



# Stimulus Generator 4002 Manual



## Imprint

Information in this document is subject to change without notice. No part of this document may be reproduced or transmitted without the express written permission of Multi Channel Systems MCS GmbH.

While every precaution has been taken in the preparation of this document, the publisher and the author assumes no responsibility for errors or omissions, or for damages resulting from the use of information contained in this document or from the use of programs and source code that may accompany it.

In no event shall the publisher and the author be liable for any loss of profit or any other commercial damage caused or alleged to have been caused directly or indirectly by this document.

© 2021 Multi Channel Systems MCS GmbH. All rights reserved.

Printed: 24.06.2021

Multi Channel Systems MCS GmbH

Aspenhaustraße 21

72770 Reutlingen

Germany

Phone +49-71 21-909 25 - 0

Fax +49-71 21-909 25 -11

[sales@multichannelsystems.com](mailto:sales@multichannelsystems.com)

[www.multichannelsystems.com](http://www.multichannelsystems.com)

Microsoft and Windows are registered trademarks of Microsoft Corporation. Products that are referred to in this document may be either trademarks and/or registered trademarks of their respective holders and should be noted as such. The publisher and the author make no claim to these trademarks.

# Table of Contents

<b>1</b>	<b>Introduction</b>	<b>5</b>
1.1	About this Manual	5
1.2	Terms of Use for MC_Stimulus II	5
1.3	Limitation of Liability	5
<b>2</b>	<b>Important Information and Instructions</b>	<b>5</b>
2.1	Operator's Obligations	6
2.2	Guarantee and Liability	6
2.3	Important Safety Advice	7
<b>3</b>	<b>First Use of the Stimulus Generator</b>	<b>8</b>
3.1	Welcome to the STG and MC_Stimulus	8
3.2	Setting Up and Connecting the STG	10
3.3	Driver Installation	11
3.4	Installing the Software	11
<b>4</b>	<b>Operating the STG</b>	<b>12</b>
4.1	Operation Overview	12
4.2	Operating Multiple STGs	15
<b>5</b>	<b>Programming Stimulus Protocols</b>	<b>16</b>
5.1	MC_Stimulus II Sample Files for STG 4000 Series	16
5.2	Neuroelectrophysiology / MEA-System	16
5.3	General Demo Files	17
5.4	MC_Stimulus II Worksheet	18
5.5	Pulse Types	19
5.6	Autorepeating Pulses and Protocols	21
5.7	Autocreating Entries and Editing Columns	24
5.8	Auto Sync for Autocreating Trigger Pulses	32
5.9	Adjusting the Stimulus Intensity Level	34
<b>6</b>	<b>ASCII Import / Export</b>	<b>35</b>
6.1	Loading Files	35
6.2	Exporting Files	36
6.3	Supported File Formats	36
<b>7</b>	<b>Stimulus Display</b>	<b>45</b>
7.1	Selecting Channels	45
7.2	Display Settings	45
7.3	Display Tools	46

<b>8</b>	<b>Downloading Stimuli</b>	<b>48</b>
8.1	Downloading Stimulus Files	48
	8.1.1 Download Modes	49
	8.1.2 Independent Channel Download	49
<b>9</b>	<b>General Software Features</b>	<b>51</b>
9.1	Customizing the Main Window	51
9.2	Menu Bar	51
9.3	Toolbar	52
9.4	Shortcut Keys	53
9.5	File Menu	53
9.6	Settings Menu	54
<b>10</b>	<b>Synchronizing Events</b>	<b>55</b>
10.1	Digital Output Signals (Sync Out)	55
10.2	Triggering Stimulation (Trigger In)	56
10.3	Trigger Settings	58
10.4	Multi File Mode	62
10.5	Batch Mode	64
<b>11</b>	<b>Analog Output Signals</b>	<b>66</b>
11.1	Output Modes	66
11.2	Voltage Mode	67
11.3	Current Mode	71
11.4	Measuring Output Signals with an Oscilloscope	74
11.5	Rise Time	75
11.6	Comparison of Output Signals in Current Mode	83
11.7	Capacitive Behavior of Stimulation Electrodes	89
<b>12</b>	<b>Troubleshooting</b>	<b>91</b>
12.1	About Troubleshooting	91
12.2	Technical Support	91
12.3	Error Messages	92
12.4	Signal terminated when using Trigger In	94
12.5	Strong Peak Artifacts	94
12.6	Output Signal Does not Match Programmed Signal	94
12.7	Internal Calibration Signals	95
<b>13</b>	<b>Appendix</b>	<b>96</b>
13.1	Technical Specifications STG 4002	96
13.2	Contact Information	98
<b>14</b>	<b>Index</b>	<b>99</b>

# 1 Introduction

## 1.1 About this Manual

This manual comprises all important information about the installation and operation of the stimulus generator STG4000 series and MC\_Stimulus II software. It is assumed that you have already a basic understanding of technical and software terms. No special skills are required to read this manual.

This documentation refers only to the STG hardware and **MC\_Stimulus II** software. For more information on the STG's DLL functions and programming of custom programs, please read the separate documentation in the Documentation folder in the MC\_Stimulus II program directory.

If you are using the STG for the first time, please read the **important safety advice** before **installing** the **hardware** and **software** (see chapter "Important Safety Advice", where you will find important information about the installation and first steps).

The **printed manual** and **help** are basically the same, so it is up to you which one you will use. The help offers you the advantage of scrolling through the text in a non-linear fashion, picking up all information you need, especially if you use the **index** and the **search** function. If you are going to read larger text passages, however, you may prefer the printed manual.

The device and the software are part of an ongoing developmental process. Please understand that the provided documentation is not always up to date. Check also the MCS web site from time to time for downloading up-to-date manuals and new software versions.

[www.multichannelsystems.com](http://www.multichannelsystems.com)

## 1.2 Terms of Use for MC\_Stimulus II

You are free to use MC\_Stimulus II for its intended purpose. You agree that you will not decompile, reverse engineer, or otherwise attempt to discover the source code of the software.

## 1.3 Limitation of Liability

Multi Channel Systems MCS GmbH makes no guarantee as to the accuracy of any and all tests and data generated by the use the MC\_Stimulus II software. It is up to the user to use good laboratory practice to establish the validity of his findings.

To the maximum extent permitted by applicable law, in no event shall Multi Channel Systems MCS GmbH or its suppliers be liable for any special, incidental, indirect, or consequential damages whatsoever (including, without limitation, injuries, damages for data loss, loss of business profits, business interruption, loss of business information, or any other pecuniary loss) arising out of the use of or inability to use MC\_Stimulus II or the provision of or failure to provide Support Services, even if Multi Channel Systems MCS GmbH has been advised of the possibility of such damages.

## 2 Important Information and Instructions

### 2.1 Operator's Obligations

The operator is obliged to allow only persons to work on the device, who

- are familiar with the safety at work and accident prevention regulations and have been instructed how to use the device;
- are professionally qualified or have specialist knowledge and training and have received instruction in the use of the device;
- have read and understood the chapter on safety and the warning instructions in this manual and confirmed this with their signature.

It must be monitored at regular intervals that the operating personnel are working safely.

Personnel still undergoing training may only work on the device under the supervision of an experienced person.

### 2.2 Guarantee and Liability

The *general conditions of sale and delivery* of Multi Channel Systems MCS GmbH always apply. The operator will receive these no later than on conclusion of the contract.

Multi Channel Systems MCS GmbH makes no guarantee as to the accuracy of any and all tests and data generated by the use of the device or the software. It is up to the user to use good laboratory practice to establish the validity of his findings.

Guarantee and liability claims in the event of injury or material damage are excluded when they are the result of one of the following.

- Improper use of the device.
- Improper installation, commissioning, operation or maintenance of the device.
- Operating the device when the safety and protective devices are defective and/or inoperable.
- Non-observance of the instructions in the manual with regard to transport, storage, installation, commissioning, operation or maintenance of the device.
- Unauthorized structural alterations to the device.
- Unauthorized modifications to the system settings.
- Inadequate monitoring of device components subject to wear.
- Improperly executed and unauthorized repairs.
- Unauthorized opening of the device or its components.
- Catastrophic events due to the effect of foreign bodies or acts of God.

## 2.3 Important Safety Advice



Warning: Make sure to read the following advice prior to install or to use the device and the software. If you do not fulfill all requirements stated below, this may lead to malfunctions or breakage of connected hardware, or even fatal injuries.



Warning: Obey always the rules of local regulations and laws. Only qualified personnel should be allowed to perform laboratory work. Work according to good laboratory practice to obtain best results and to minimize risks.

The product has been built to the state of the art and in accordance with recognized safety engineering rules. The device may only

- be used for its **intended purpose**;
- be used when in a **perfect condition**.
- Improper use could lead to serious, even fatal injuries to the user or third parties and damage to the device itself or other material damage.



Warning: The device and the software are **not** intended for medical uses and **must not** be used on humans. MCS assumes no responsibility in any case of contravention.

Malfunctions which could impair safety should be rectified immediately.

### High Voltage

Electrical cords must be properly laid and installed. The length and quality of the cords must be in accordance with local provisions.

Only qualified technicians may work on the electrical system. It is essential that the accident prevention regulations and those of the employers' liability associations are observed.

- Each time before starting up, make sure that the **mains supply** agrees with the specifications of the product.
- Check the **power cord** for damage each time the site is changed. Damaged power cords should be replaced immediately and may never be reused.
- Check the **leads** for damage. Damaged leads should be replaced immediately and may never be reused.
- Do not try to insert anything sharp or metallic into the vents or the case.
- Liquids may cause short circuits or other damage. Keep the device and the power cords always **dry**. Do **not** handle it with wet hands.

### Requirements for the installation

- Make sure that the device is not exposed to direct sunlight. Do not place anything on top of the device, and do not place it on top of another heat producing device. Otherwise, the device may overheat.

## 3 First Use of the Stimulus Generator

### 3.1 Welcome to the STG and MC\_Stimulus

#### Product line overview

Stimulus generators of the 4000 series are general purpose stimulators designed for a wide variety of applications, both *in vitro* and *in vivo*.

Flexible and easy-to-use MC\_Stimulus software enables complex stimulus waveforms (both **current** and **voltage**). Waveforms designed in the program or imported from an external ASCII file are converted by the connected STGs into pulses, which are sent to stimulating electrodes. Stimulus isolation units (**SIU**) for **each** channel are included. Thus, no external SIUs are required.

A trigger input and output for TTL signals allows to synchronize the stimulus generator with other instruments. Triggering of other devices via programmable TTL pulses (**Sync Out**) is possible, as well as triggering of the STG by external devices via the **Trigger In** input. For example, you can synchronize **stimulation** and **recording** with a TTL signal sent from the **Sync Out** output of the STG to the data acquisition system, for example, the MC\_Card or an USB based data acquisition device.

Stimulus generators are available with two, four or eight completely independent stimulation channels (STG4002, STG4004, STG4008). Each channel is freely programmable, combination of channels to achieve complex stimulation patterns is not necessary.

#### STG 4002



The real-time stimulus generator of the 4000 series is an advanced version and the world's first STG that is able to send continuous pulse streams for stimulation of electrodes. In addition, you can trigger all (up to 8) channels **separately** by external TTL pulses.

The STG 4000 series operates in **Download** mode.

In **Download** mode, you can control the STG either by the **MC\_Stimulus II** or by a custom program. Stimulus protocols are created in **MC\_Stimulus II** or the custom program; complete protocols are downloaded onto the STG, and can after the download be executed without a computer connection. **MC\_Stimulus II** is downward compatible to **MC\_Stimulus** (for controlling the 1000 series), that means, you can load stimulus protocols generated by **MC\_Stimulus** into **MC\_Stimulus II**, but not the other way round.

Custom applications for the **Download** mode can be programmed in Matlab, Labview, C/C++, and Visual Basic. This documentation refers only to the STG hardware and **MC\_Stimulus II** software. For more information on the STG's DLL functions and programming of custom software, please read the separate documentation in <https://www.multichannelsystems.com/software/mcsusbnetdll>.



## MC\_Stimulus II

Stimuli are created user-friendly by entering the desired pulses (**rectangular**, **ramp**, or **sine** waveforms) into a **worksheet**. Waveforms can be combined freely to create virtually any stimulus pattern.

Created stimuli are displayed in a **WYSIWYG stimulus display**. All channels are set up separately.

For even more convenience, **repetitive** stimulus patterns do not have to be entered separately, but can be **grouped** and **looped**. You can also **import** waveforms in **ASCII** file format and use them for stimulation. You can **print** and **save** stimuli and **comments** for later use and documentation of your experiments.

### Creating Stimuli

Menu    Toolbar

Stimulus protocol worksheet:  
Generate and edit protocols.

Combine pulse types:  
Use a separate row  
for each pulse type

You can repeat rows  
and groups of rows.

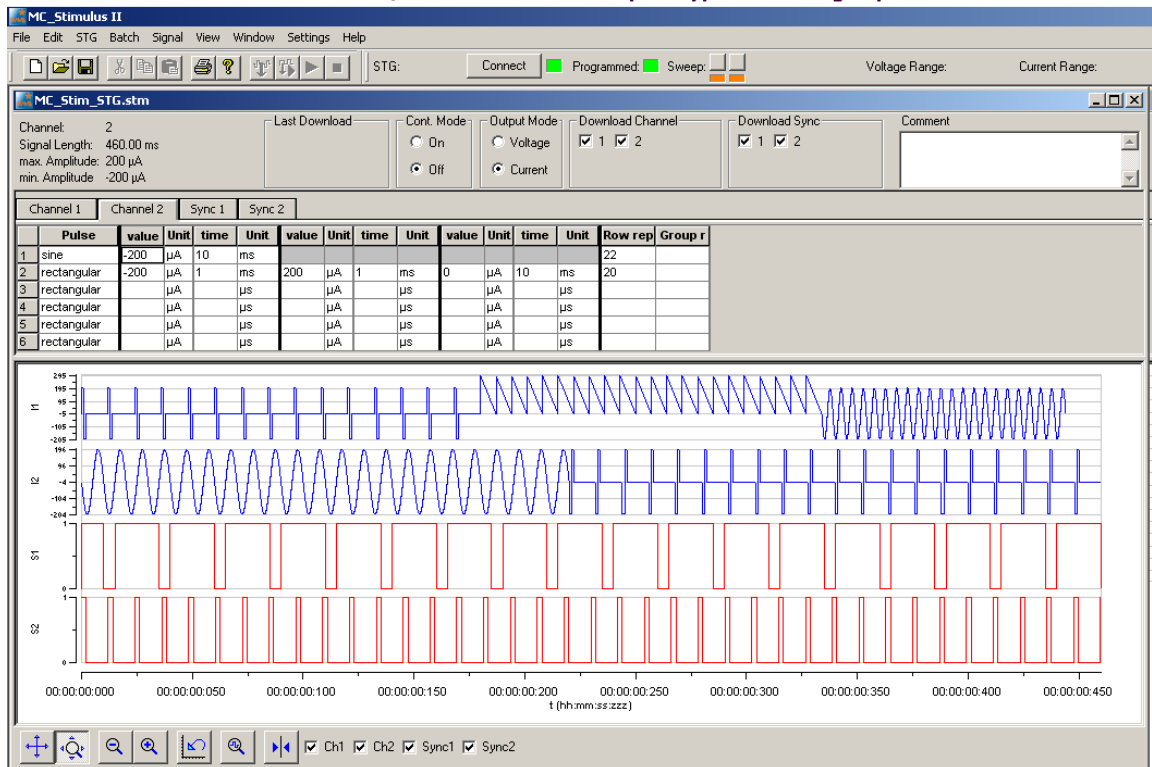

## 3.2 Setting Up and Connecting the STG

Note: You can use a USB hub for connecting the STG to the computer, for example, if you have no free USB port or if you need to extend the USB cable. This does not matter if you want to use the **Download** mode (via MC\_Stimulus II or custom program) only.

Provide a **power supply** and a **computer** with USB port in the immediate vicinity of the installation site. Make sure the STG is **switched off** before you connect it to the power supply.

1. Place the STG on a stable surface, where the air can circulate freely and the STG is not exposed to direct sunlight.
2. Connect the external power supply to the STG.
3. Connect the external power supply to the power outlet.
4. Connect the USB connector to the USB port of the computer. The computer connection is necessary for **programming** the STG, but **not** for operating it (except in **Batch** mode).
5. Connect the + and - plugs of the required output channels with 2 mm plug cables to the stimulating electrodes. Connect the appropriate ground to the ground input of the stimulation setup, for example, to the ground input of the MEA1060 amplifier. Current and voltage driven stimulation is generated from the same outputs.
6. (Optional) Connect the required Trigger In inputs with BNC cables to instruments that produce TTL signals for triggering the STG.
7. (Optional) Connect the required Sync Out outputs with BNC cables to following instruments that you want to be triggered by TTL signals from the STG, for example to one of the 16 digital inputs of the MC\_Card or of an USB based data acquisition device.
8. Switch the STG on by pressing the toggle switch on the rear panel.

### STG 4002 Front Panel



### STG 4002 Rear Panel



### 3.3 Driver Installation

The stimulus generator is a plug and play device. The driver is automatically installed together with the MC\_Stimulus II program.

The Microsoft Windows ® operating system detects a new hardware when the stimulus generator is connected to the computer, if the program has not been installed beforehand. Simply cancel the driver installation and proceed with the installation of the MC\_Stimulus II program.

**Important:** Please make sure that you have full control over your computer as an **administrator**. Otherwise, it is possible that the installed hardware does not work properly.

If there are any problems, and you need to install or update the driver manually, please see the MC\_Stimulus II help for more information.

### 3.4 Installing the Software

#### System requirements

Software: One of the following Microsoft Windows ® operating systems is required: **Windows 10, 8.1 and 7, (English and German versions supported).**

Hardware: **USB** port (2.0 High Speed)

#### Installing the software

Please check the system requirements before you install the software. MCS cannot guarantee that the software works properly if these requirements are not fulfilled.

**Important:** Please make sure that you have full control over your computer as an **administrator**. Otherwise, it is possible that the installed software does not work properly.

1. Double-click **Setup.exe** on the installation volume. The installation assistant will show up and guide you through the installation procedure.
2. Follow the instructions of the installation assistant. Please select the appropriate maximum number of analog output channels according to the connected STG. If you have different STGs in use, choose the highest number.

For the devices with internal stimulation, STG3008-FA and MEA32-STIM4 separate manuals are available.

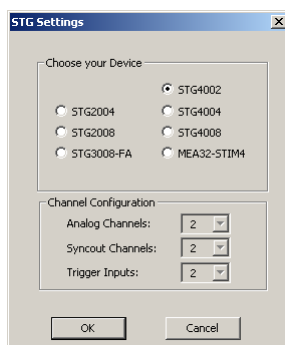

After finishing the installation of the MC\_Stimulus II software and the STG driver, you can operate the STG.

## 4 Operating the STG

### 4.1 Operation Overview



Warning: Make sure that you do not come in contact with the cables or the connectors of the STG after you have started the STG. The high voltage and power can lead to **injuries**.



Warning: Do not start the STG if you are unsure about the channel configuration or the nature of the downloaded file.

1. Set up your experiment.
2. Switch the STG on.

**Note:** It is recommended to start the STG ten minutes before use to allow warming up!

1. Set up your stimuli with the MC\_Stimulus II program.
2. Send the stimulus sequence from a MC\_Stimulus II file to the STG.
3. Start the STG either manually by pressing the **Start / Stop** button on the front panel, with the **software controls**, or with an **external trigger**.



#### Creating stimuli

Stimuli are created user-friendly by entering the desired pulses (rectangular, ramp, or sine waveforms) into a MC\_Stimulus worksheet. Waveforms can be combined freely to create virtually any stimulus pattern. Created stimuli are displayed in a WYSIWYG window.

#### Starting stimulation

**Note:** You need a computer connection only when you are using the software controls for starting and stopping the stimulus generator. When you are using the STG interface or an external control, a trigger for example, you can disconnect the stimulus generator from the computer and operate it independently. But you cannot remove the STG from the power connection. The memory is cleared when the STG has lost power.

After the download of the stimulus file on the STG, you can start the stimulation. There are several ways to start the STG.

**MC\_Stimulus II interface:** You can start the stimulation directly after the download (with the command **Download and Start**  or also later with the command **Start** . You can stop stimulation with the command **Stop** . Starting the STG by using the **Start** command is considered as activating **all** trigger inputs, that is, **all** channels are started, and **all** Sync Out outputs are active. Likewise, **all** channels are stopped when you click **Stop**.

You can start the stimulation after download  on both trigger **separately**. Please use the combined LED / Start / Stop buttons. You can start and stop the stimulation **manual** whenever you want by clicking the corresponding LED / Start / Stop button. The LED indicates the status: Grey means trigger off, red means trigger on. The first button on the left side belongs to trigger 1, the second button to trigger 2.

**STG interface:** You can start the stimulation by pressing the **Start / Stop** button on the **front panel** of the STG. Press the button again to stop the stimulation. Starting the STG

by pressing the **Start / Stop** button is considered as activating **all** trigger inputs, that is, **all** channels are started and stopped, and **all** Sync Out outputs are active when the STG is started. Pressing the **Start / Stop** button **stops** the stimulation if at least **one** channel is still active in the moment of the trigger event (indicated by the lighting SWEEP LED). Pressing the button **starts** stimulation only if **no** channel is active (dark SWEEP LED)

**External control:** You can start the stimulation on a **trigger** from an external device, for example, a switch. You can use both trigger inputs that independently trigger the analog output channels that you have assigned to them. The trigger works in a similar way as when you press the **Start / Stop** button. You can choose the action that will be taken when one of the channels that are assigned to the respective trigger input is still active. Either the stimulus protocols on the triggered channels are **stopped** or **restarted**; or the trigger event is **ignored**. There is also a **separate** Sync Out output for **each** Trigger In trigger input. You can assign the Sync Outs to the trigger inputs. The default settings define that Sync Out 1 is active when Trigger In 1 is triggered, and so on. Please see chapter “Trigger Settings” for more details.

### STG status control

Three status control LEDs (light-emitting diode) are present on the front panel of the STG to give you a quick overview on its status.

**POWER** STG has been switched on.

**PROG** Stimulus file was downloaded to STG. STG is now ready for operation.

**SWEEP** Stimulation is running, that is, at least one output channel is active.

### MC\_Stimulus II status control

The top part of the MC\_Stimulus II status control refers to the active instance of the MC\_Stimulus program instance and the STG that is controlled by this instance. All information in this part is saved on the STG. The information is updated in the MC\_Stimulus II main window when the connection to the STG is changed or interrupted.

<i>Status light</i>	<i>Color</i>	<i>Meaning</i>
<b>Connected</b>	Green	The STG is connected and switched on. The serial number serves as an ID for the controlled STG and is displayed on the left. On the <b>STG</b> menu, click <b>Select Device</b> to select another STG connected to a different USB port from the drop-down list to switch STGs.
<b>Programmed</b>	Green	Stimulus file in voltage mode has been downloaded to the STG. The STG is now ready for operation. File name and path of the *.stm file that was downloaded onto the STG are displayed on the right.
	Orange	Stimulus file in current mode has been downloaded to the STG. The STG is now ready for operation. File name and path of the *.stm file that was downloaded onto the STG are displayed on the right.
<b>Sweep</b>	Red	Indicates the active <b>trigger</b> . Each stimulation channel can be assigned to any trigger. If all channels are assigned to trigger one for example, only one sweep indicator will light up, even though all stimulation channels can be active. See also Triggering Stimulation.

### STG and Stimulus Protocol Information:

**Information on the STG hardware**      **Serial number**   **STG status light**   **Sweep LED Start / Stop**   **Voltage and current range**

The screenshot shows the 'MC\_Stimulus II - MC\_Stimulus\_Main\_Menu\_File.stm' window. The top toolbar includes a 'Disconnect' button, a green 'Programmed' indicator, a 'Sweep' indicator, and fields for 'Voltage Range: ± 8000 mV' and 'Current Range: ± 1600 µA'. Below this is the 'MC\_Stimulus\_II\_in\_Menu\_File.stm' window, which displays stimulus protocol parameters for Channel 1: Signal Length (9.920 ms), max. Amplitude (2.500 V), min. Amplitude (-3.000 V), Last Download (80002, 22.01.2010 14:14), Cont. Mode (On), Output Mode (Voltage), Download Channel (1, 2), and Download Sync (1, 2). A 'Comment' field is also present.

**Stimulus protocol parameter on the active channel page**      **Last download time of stimulus protocol and STG ID**      **Mode of the STG**      **Channel selection for next download**      **Comment field**

**Information on the stimulus protocol (\*.stim file)**

## Autocalibration

During the first ten minutes after starting the STG, the device emits every minute high frequency signals (small bursts) for internal offset calibration of the current outputs in a range of +/- 10 mV. After warming up the STG, the calibration signals later will be delivered half-hourly.

**Note:** It is recommended to start the STG ten minutes before use to allow warming up!

High sensitive measuring equipments will monitor these calibration signals as artefacts which might disturb the stimulation when using very low stimulus pulses < 100 µA in current mode. Enable the option "Disable Autocalibration" in STG main menu to avoid the autocalibration. Download the command to the STG.

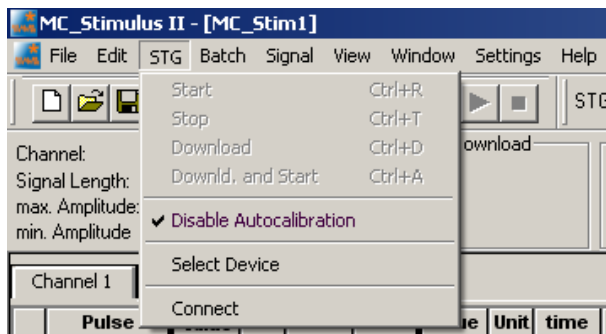

## 4.2 Operating Multiple STGs

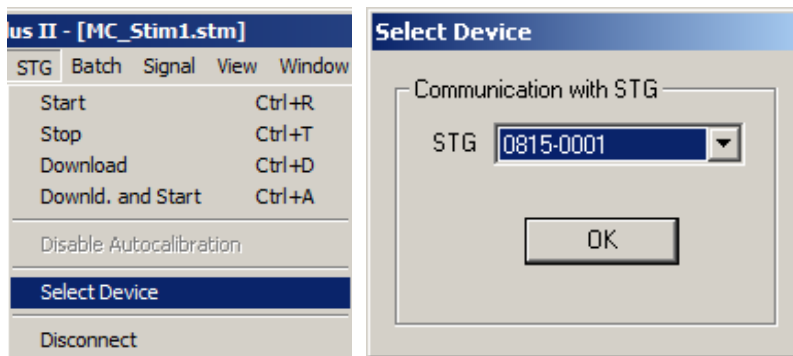

If you have more than one STG connected to the same computer, please click under "STG" in main menu "**Select Device**". In the "Select Device" dialog you can choose which STG you like to control from the currently active MC\_Stimulus II program.

- The serial number is printed on the STG's case. The **serial number** of the currently active STG is displayed on the status bar of the currently active instance of the MC\_Stimulus II program.



- Click **Select Device** under STG in main menu. Select the serial number of the desired STG from the **STG** list.
- You can open multiple instances of the MC\_Stimulus II program and control multiple STGs at the **same** time. Please make sure that you control **each** STG only by **one** MC\_Stimulus II instance.
- You can also open only **one** MC\_Stimulus II instance and control multiple STGs one **after** the other by the same instance. Simply change the settings in the **Select Device** dialog and select the next STG when you have finished to program the first. The STGs can be operated without a computer connection.

## 5 Programming Stimulus Protocols

### 5.1 MC\_Stimulus II Sample Files for STG 4000 Series

These sample files are intended for demonstrating basic features of the Stimulus Generator 4002, for basic applications with the MEA System. If you are using a MEA-System, please see also the MC\_Rack tutorial in the MC\_Rack help or the separate PDF on the installation volume.

The sample files are automatically installed to the **Examples** folder in the MC\_Stimulus II program directory.

**Note:** The demo files were kindly provided by STG users. MCS does not guarantee that these files will be appropriate for your application and stimulating electrode type. For using MEA electrodes as stimulating electrodes, MCS recommends the use of monopolar voltage pulses, though some MEA users feel that they have better results with bipolar voltage pulses, depending on the cell culture or tissue used.



**Warning:** Always obey the recommendations of the stimulating electrode manufacturer.

### 5.2 Neuroelectrophysiology / MEA-System

#### **LTP-Induction.stm**

- Stimulus type: Pulse train of 100 biphasic pulses for LTP induction
- Amplitude: 1.5 V
- Duration: 100  $\mu$ s per phase
- Inter-Stimulus-Interval / frequency: 10 ms / 100 Hz

#### **LTP-Testpulse.stm**

- Stimulus type: Biphasic test pulse
- Amplitude: 1.5 V
- Duration: 100  $\mu$ s per phase
- Inter-Stimulus-Interval: 60 s

#### **PairedPulse.stm**

- Stimulus type: Paired biphasic test pulse for paired pulse facilitation and depression
- Amplitude: 2 V
- Duration: 100  $\mu$ s per phase
- Inter-Stimulus-Interval: 20 ms between paired pulses, 10 s between pairs



### **IOcurve-500-3000.stm**

- Stimulus type: Voltage step series with biphasic pulses for I/O analysis
- Amplitude: 500 mV to 3 V, increments of 250 mV, 3 repeats
- Duration: 100  $\mu$ s per phase
- Inter-Stimulus-Interval: 10 s

### **monophasic\_voltage\_1V\_100 $\mu$ s.stm**

- Stimulus type: Monophasic test pulse
- Amplitude: 1 V
- Duration: 100  $\mu$ s
- Inter-Stimulus-Interval: 24 ms

### **biphasic\_voltage\_1V\_100 $\mu$ s.stm**

- Stimulus type: Biphasic test pulse
- Amplitude: 1 V
- Duration: 100  $\mu$ s per phase
- Inter-Stimulus-Interval: 24 ms

### **ASCII-Import-Biopotential.stm**

This file is not intended for a real experiment, but demonstrates the ASCII import feature. Shown is a single spike recorded from an organotypic hippocampal culture with the MEA System. The spike waveform was exported as ASCII from MC\_Rack and imported into the MC\_Stimulus II program. The imported file is "ASCII\_Import\_Biopotential.dat".

## **5.3 General Demo Files**

### **Demo\_Waveforms.stm**

This file is not intended for a real experiment, but for demonstrating the capabilities of the stimulus generator. The file includes stimuli with increasing inter-stimulus interval and with increasing amplitude, ramps and sine waveforms.

## 5.4 MC\_Stimulus II Worksheet

You can freely combine any pulse types. Use a separate row for each pulse type.

**Hint:** Several tools are provided for editing whole columns at once or autocreating entries.

1. Select the desired **output type** first. Click either **Voltage** or **Current** under **Output Mode** on the file window of MC\_Stimulus.

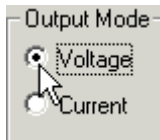

**Note:** In current mode, a protection switch disconnects the current source from the electrode, to avoid leak currents. The switch opens as soon as the stimulation pattern starts. To allow some time for the switch to open, it is recommended to start current pulses with a short period of 0  $\mu$ A. 40  $\mu$ s is sufficient.

2. Click a tab to select an **output channel**. The according channel worksheet is brought to front.

	Channel 1	Channel 2	Channel 3	Channel 4			
	<b>Pulse</b>	<b>value</b>	<b>Unit</b>	<b>time</b>	<b>Unit</b>	<b>value</b>	<b>Un</b>
1	rectangular		mV		$\mu$ s		mV
2	rectangular		mV		$\mu$ s		mV
3	rectangular		mV		$\mu$ s		mV
4	rectangular		mV		$\mu$ s		mV
5	rectangular		mV		$\mu$ s		mV
6	rectangular		mV		$\mu$ s		mV

3. Now you can enter the pulses into the worksheet. Select a **Pulse** type (either **rectangular**, **ramp**, or **sine**).
4. Enter the desired voltage steps and a time length for each step.

	Channel 1	Channel 2	Channel 3	Channel 4			
	<b>Pulse</b>	<b>value</b>	<b>Unit</b>	<b>time</b>	<b>Unit</b>	<b>value</b>	<b>Un</b>
1	rectangular	-1000	mV	10	ms		mV
2	rectangular		mV		$\mu$ s		mV
3	rectangular		mV		ms		mV
4	rectangular		mV		s		mV
5	rectangular		mV		min		mV
6	rectangular		mV		h		mV

5. The according pulse is displayed in the WYSIWYG display at once.

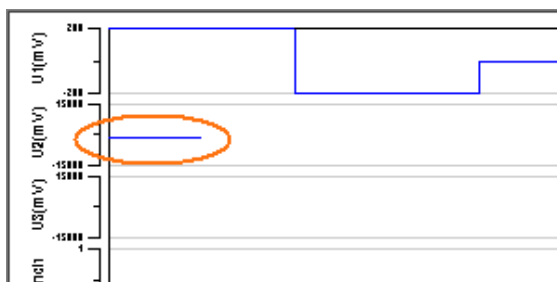

## 5.5 Pulse Types

Three basic pulse types are available in MC\_Stimulus II. You can create virtually any pulse by combining different types:

- Rectangular
- Ramp
- Sine wave

Note: The **time resolution is 20  $\mu\text{s}$** . When you enter time steps that are not a multiple of 20  $\mu\text{s}$ , the length of the step is **internally** adjusted (rounded arithmetically, that is, 249  $\mu\text{s}$  would be rounded down to 240  $\mu\text{s}$ , 250 would be rounded up to 260  $\mu\text{s}$ ) to a valid value. The minimum voltage resolution is **1 mV**, the current resolution is **200 nA**. Please regard also the **minimum and maximum output voltage / current** of your STG version. If you enter voltage or current values outside the STG's limit, the invalid value will be changed automatically when you download the protocol. Cells with changed values will be highlighted in yellow.

Note: If you work **near** the resolution **limits** of the STG, the **output pulses may differ from the programmed pulses**. In this case, you should check the output with an oscilloscope. Please see also the "Analog Output Signals" chapter.

Channel 1	Channel 2	Sync 1		
	Pulse	value	Unit	time
1	rectangular	-1000	$\mu\text{A}$	30
2	rectangular		$\mu\text{A}$	
3	rectangular		$\mu\text{A}$	
4	rectangular		$\mu\text{A}$	
5	rectangular		$\mu\text{A}$	
6	rectangular		$\mu\text{A}$	

Please note that the memory of the STG4002 is limited (64 MB). You will get an error message if the memory is full.

For the digital **Sync** channels, only TTL pulses with bit patterns of 0 (LOW) and 1 (HIGH) can be programmed. A logical state of **1 (HIGH)** results in a **3.3 V** output signal, and a logical state of **0 (LOW)** results in a **0 V** output. Please note that the digital output is sent about **20  $\mu\text{s}$  faster** than the analog output. Please see also the "Triggering Stimulation" chapter.

## Rectangular pulse type

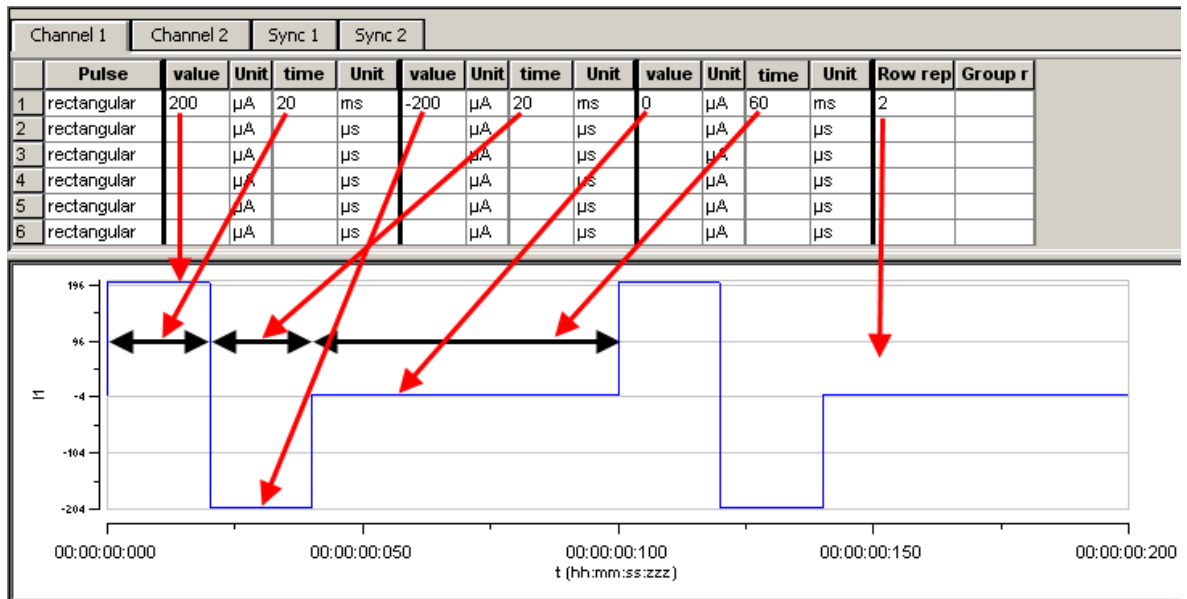

Enter each voltage / current **level** and the **duration** of the pulse. The voltage / current jumps directly to the specified level. In one row, you can enter up to three voltage / current levels. Use the next row for programming more levels.

## Ramp pulse type

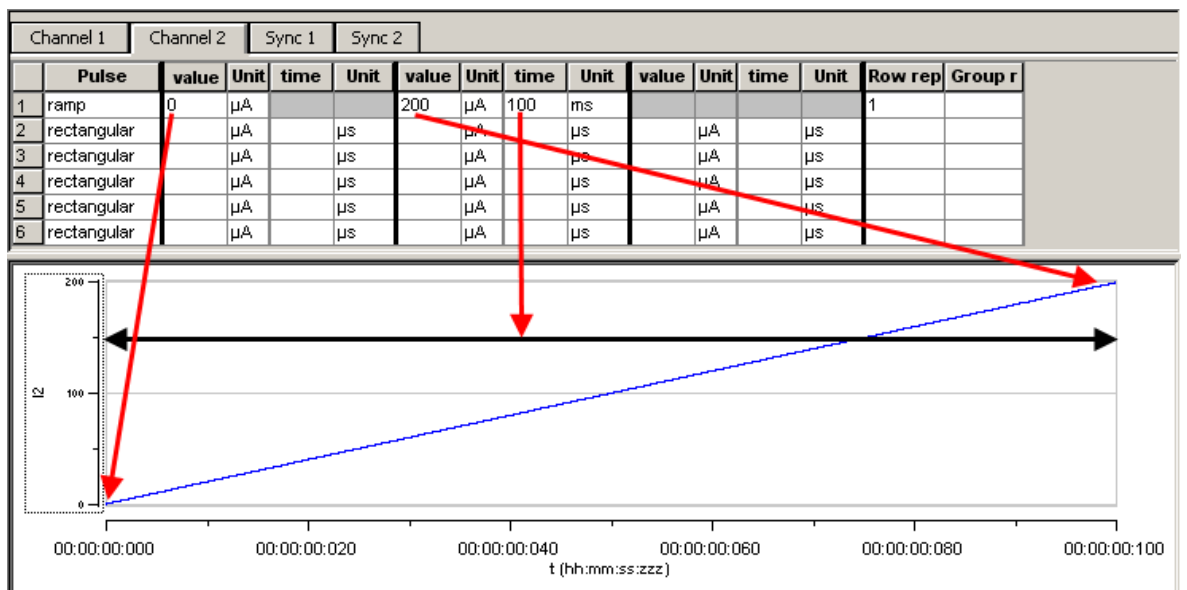

Define the **starting point**, **end point**, and the **length** of the ramp. The ramp is then build according to these parameters in small single steps of 20  $\mu\text{s}$ .

## Sine wave pulse type

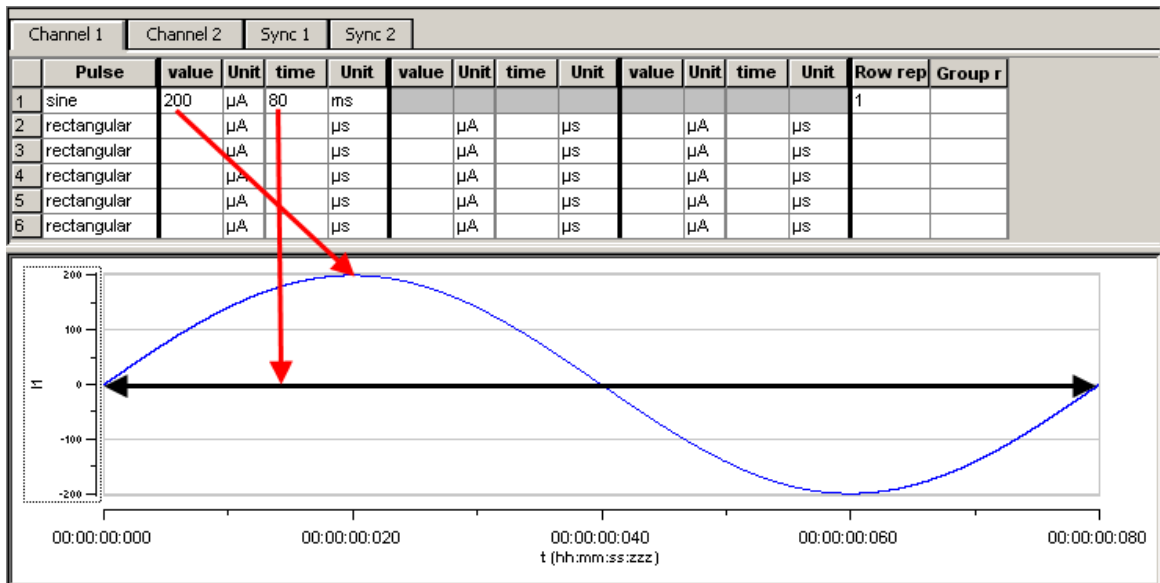

Define the **amplitude** and the **period** of the sine wave. The sine wave is then computed according to these parameters with a minimum resolution of 1 mV and 20  $\mu\text{s}$ . If you enter a negative amplitude, the sine wave starts with its negative alternation.

## 5.6 Autorepeating Pulses and Protocols

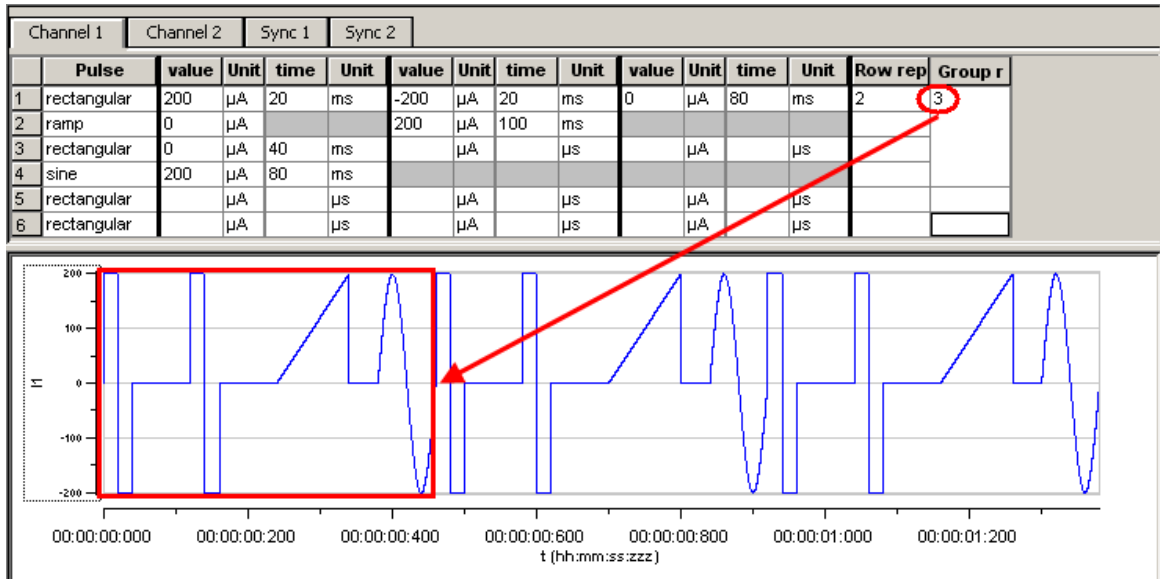

For entering complex stimuli easier and faster, you can **repeat rows** and **groups** instead of entering the pulses several times into the worksheet. You can repeat each single row. In the preceding example, the rectangular pulse in row 1 is repeated twice. You can also group several rows and repeat them altogether. In the example, pulses from rows 1 to 4 are grouped and repeated three times.

## Repeating rows

Type the number of repeats into the **Row Repeat** cell of the appropriate row. The pulses of the complete row are repeated the specified number of times.

## Grouping and repeating groups

1. Select several cells by clicking and dragging cells in the **Group Repeat** column. Selected cells are highlighted in black.
2. Point to the selected cells and right-click to open the context menu.

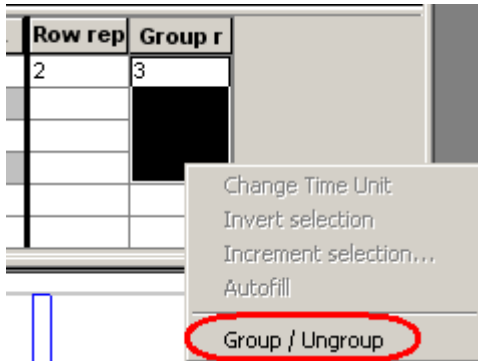

3. Click **Group / Ungroup**. The corresponding rows are grouped now. This is indicated by a merging of the **Group Repeat** cells.
4. Type the number of repeats into the merged **Group Repeat** cell.

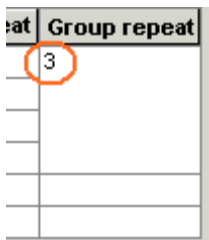

## Repeating complete pulse protocols (autorepeat function), Continuous Mode

You can repeat the complete stimulus on all output channels that are triggered by the same **trigger**. This means, each time when a trigger event occurs, the complete stimuli on all corresponding output channels are repeated for the specified number of times. If the stimuli have different lengths, the starting points are **synchronized**. For example, if channel 1 has a stimulus with a length of 500 ms, and channel 2 of 1000 ms, and both are triggered by the same trigger event, channel 1 waits 500 ms for the repeat until the output stream of channel 2 has been finished.

**Note:** The Sync Out signal for the corresponding trigger is repeated as well each time the stimulus is repeated.

**Hint:** You can repeat the complete stimulus protocol that is assigned to a trigger **continuously** by using the **Continuous Mode** setting. Continuous mode can be activated in the main window or under Trigger Settings. The STG has then to be stopped manually by the user. You can use this feature regardless whether you use an external trigger input or not. When you press the **Start** button, this is considered as if all trigger inputs were active. When you use Continuous Mode, the repeats entered in the Trigger Settings dialog box are disabled.

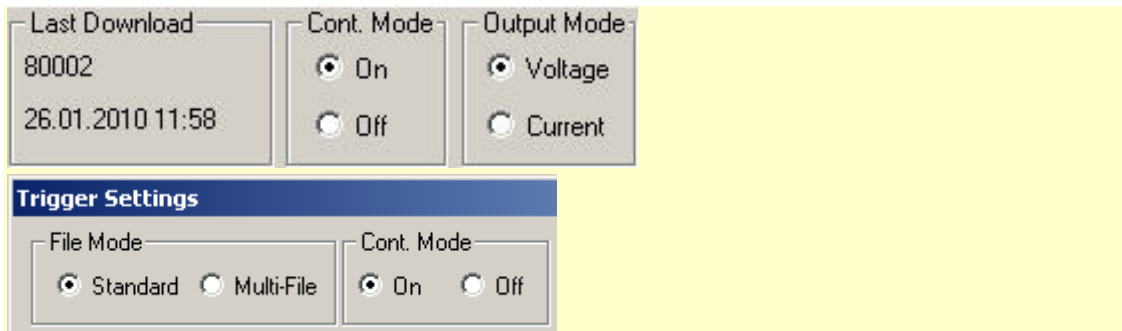

On the **STG** menu, click **Trigger Settings**.

Enter the number of repeats for each trigger separately. 0 repeats the output signals continuously.

In the following example, the stimuli on output channels 1 and 2 triggered by Trigger 1 are repeated **three times** after the trigger event, each time accompanied by the Sync Out 1 output. All other stimuli are applied **once** after their respective trigger event.

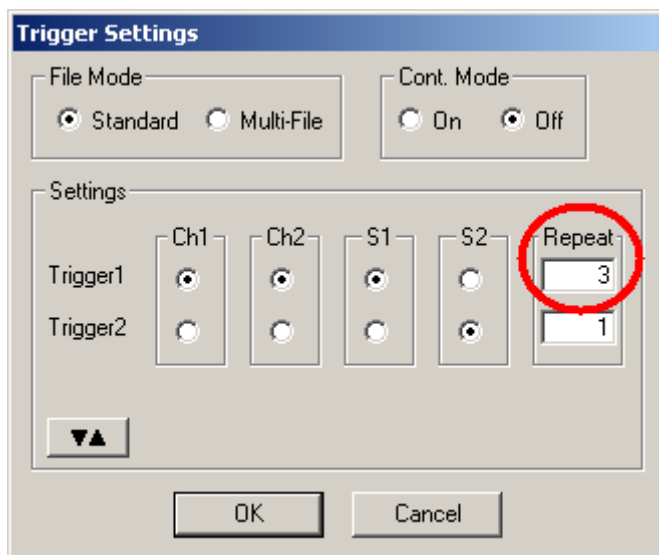

### Repeating complete pulse protocols, Gating Trigger

Repeated stimulation of complete protocols can also be controlled by a gating trigger. Channels associated with a Trigger input will be active as long as the condition of that Trigger is 1 (HIGH) and switched off as soon as the condition becomes 0 (LOW). Gating trigger function can be enabled in the Trigger Settings menu.

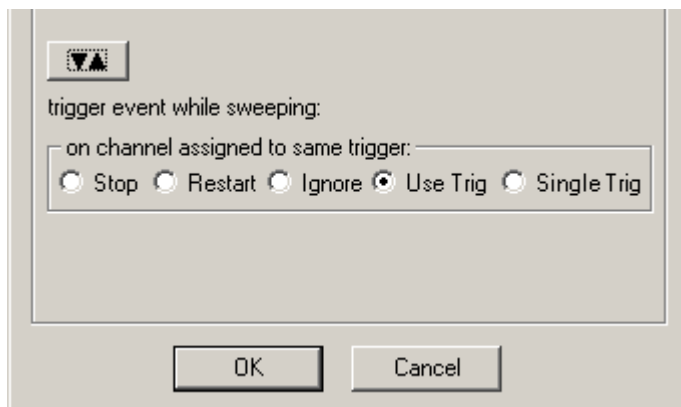

## 5.7 Autocreating Entries and Editing Columns

### Changing time units for a complete column

1. Click any **Unit** column header to select a column. The selected column is highlighted in black.
2. Right-click and click **Change Time Unit**.

	Pulse	value	Unit	time	Unit
1	rectangular	-200	$\mu\text{A}$	60	$\mu\text{s}$
2	rectangular		$\mu\text{A}$		$\mu\text{s}$
3	rectangular		$\mu\text{A}$		$\mu\text{s}$
4	rectangular		$\mu\text{A}$		$\mu\text{s}$
5	rectangular		$\mu\text{A}$		$\mu\text{s}$
6	rectangular		$\mu\text{A}$		$\mu\text{s}$

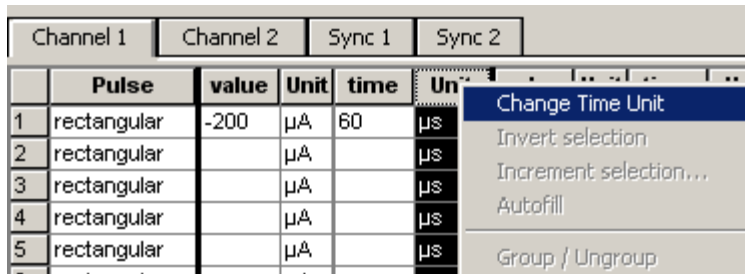

3. Select the desired time unit.

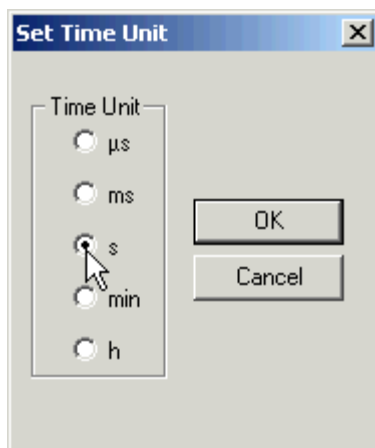

All units in the column are set to the selected time unit.

	Pulse	value	Unit	time	Unit
1	rectangular	-200	$\mu\text{A}$	60	s
2	rectangular		$\mu\text{A}$		s
3	rectangular		$\mu\text{A}$		s
4	rectangular		$\mu\text{A}$		s
5	rectangular		$\mu\text{A}$		s
6	rectangular		$\mu\text{A}$		s



## Inverting pulses in a column

1. Click any **Value** column header to select a column. The selected column is highlighted in black.
2. Right-click and click **Invert Selection**.

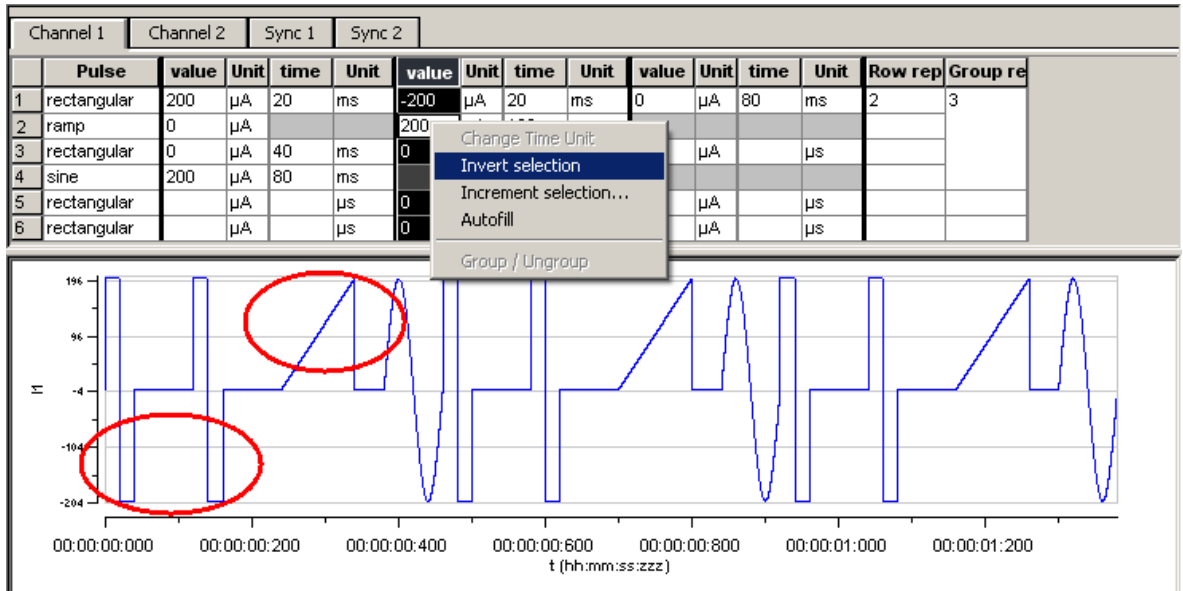

The polarity of the signals is switched from positive to negative and vice versa.

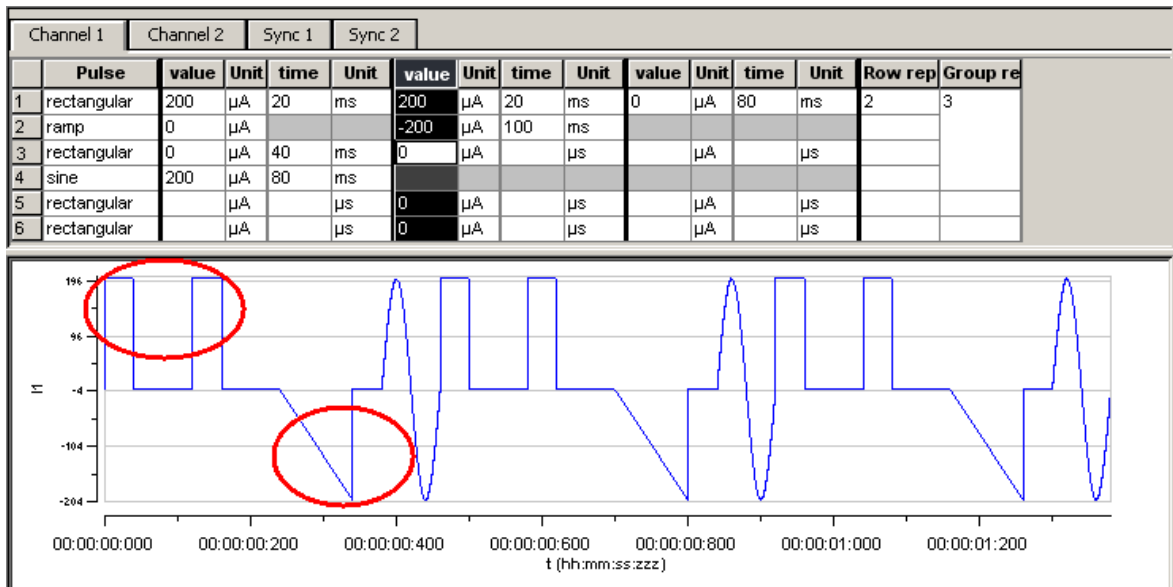

## Incrementing columns

This feature is very convenient for setting up long and complex stimuli without entering each value manually. You can enter and edit multiple voltage values or time lengths.

You can keep all zero values **unchanged** with the option **Keep Zero**.

Apart from an absolute shift or increment factor, you can modify values by the **percentage** as well.

## Shifting time or voltage / current values

You enter a value, which is added arithmetically to all values in the selected column. For example, if you enter "-50", -50 is added to all values.

1. Click any **Value** or **Time** column header to select a column. The selected column is highlighted in black.
2. Right-click and click **Increment Selection**.

	Pulse	value	Unit	time	Unit	value	Unit	time	Unit	value	Unit	time	Unit	Row rep	Group r
1	rectangular	10	µA		µs		µA		µs		µA		µs		
2	rectangular	20	µA		µs		µA		µs		µA		µs		
3	rectangular	30	µA		µs		µA		µs		µA		µs		
4	rectangular	40	µA		µs		µA		µs		µA		µs		
5	rectangular	50	µA		µs		µA		µs		µA		µs		
6	rectangular	60	µA		µs		µA		µs		µA		µs		

Graph axes: y-axis from -1000 to 1000, x-axis from 00:00:00:000 to 00:00:00:001 (t (hh:mm:ss:zzz)).

3. Under **Type of Increment**, select **Shift**.
4. Enter the desired value.

Channel 1 Channel 2 S

	Pulse	value	Unit
1	rectangular		µA
2	rectangular		µA
3	rectangular		µA
4	rectangular		µA
5	rectangular		µA
6	rectangular		µA

Graph axes: y-axis from 400 to 1600.

**Increment selected column**

Increment selected values  
by: 100  %

Type of Increment  
 Count  Keep Zero  
 **Shift**  
 Absolute value

OK Cancel

All values in the selected column are modified by the selected factor. In the example, 100 is added to all values, resulting in a total of 100 because the initial value has been 0.

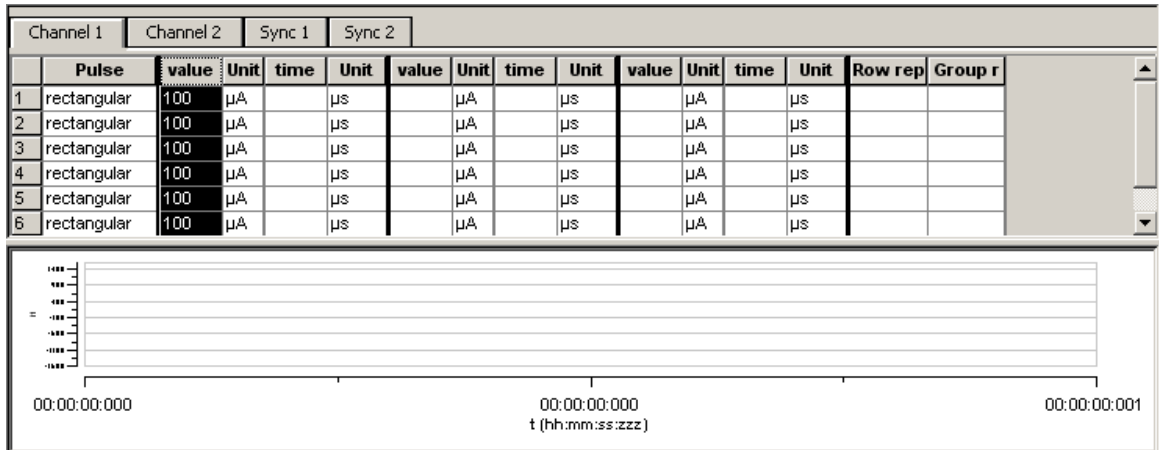

### Creating time or voltage / current increments

With this option, you enter a base value for modification of all values in the selected column. The first row is modified by the base value. The second row is modified by the double value, the third row by thrice the base value, and so on. With this feature, you can easily set up time or voltage increments.

1. Under **Type of Increment**, select **Count**.
2. Enter the desired start value.

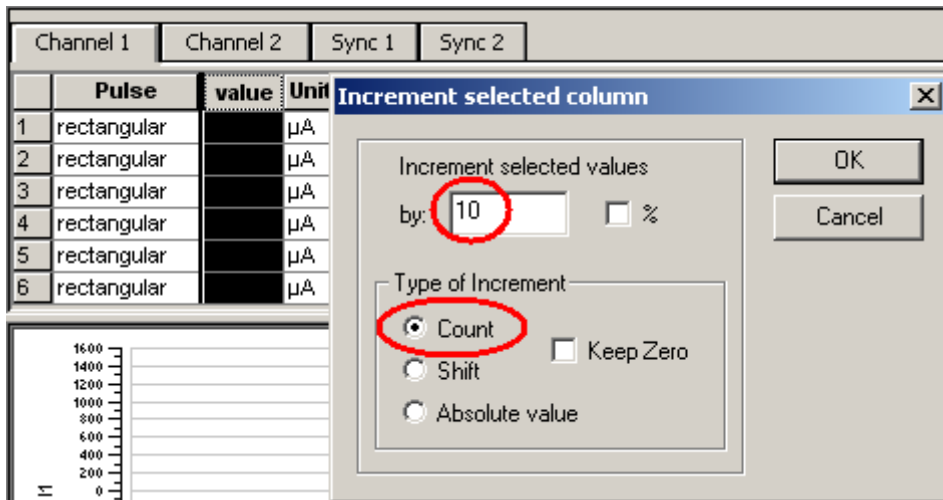

The value in the first row is incremented by the selected start value of 10. The next value is modified by the double value (20), and so on.

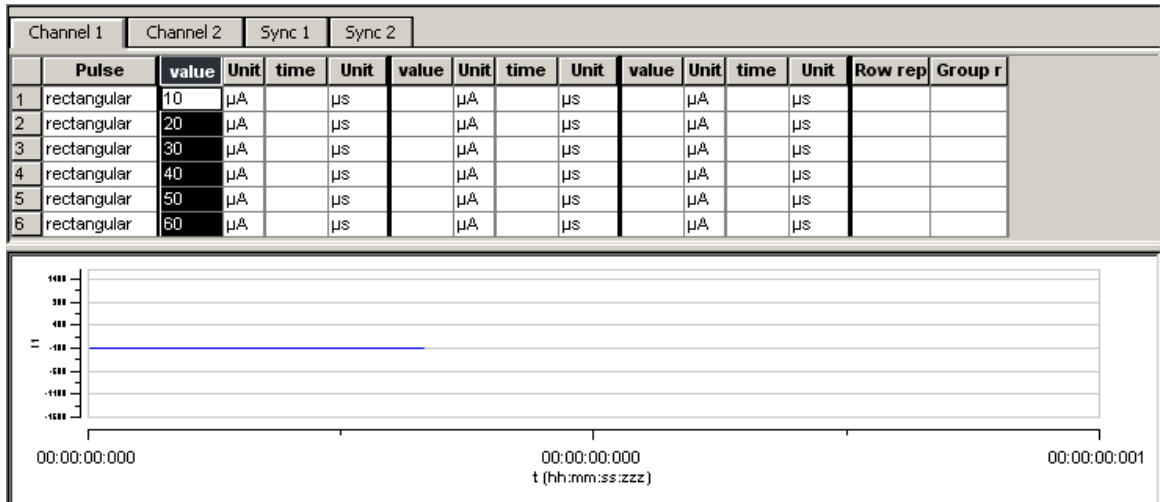

You can now fill further columns in the same way. Thus, you can easily set up a stimulus with incremented pulse lengths like this with only a few mouse-clicks.

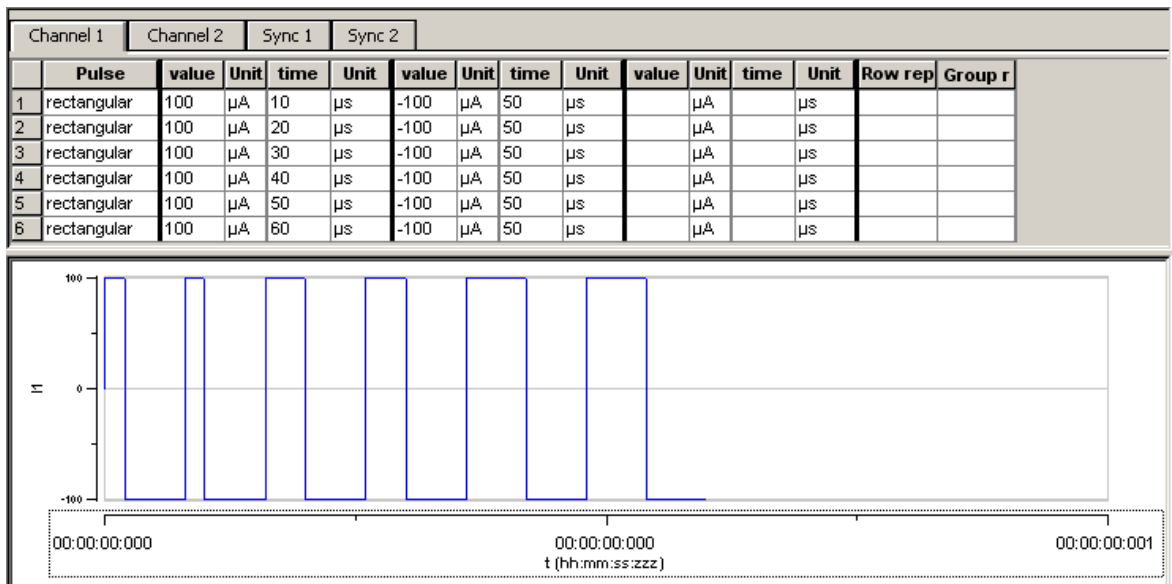

In the same way, you can set up a stimulus with voltage / current increments.

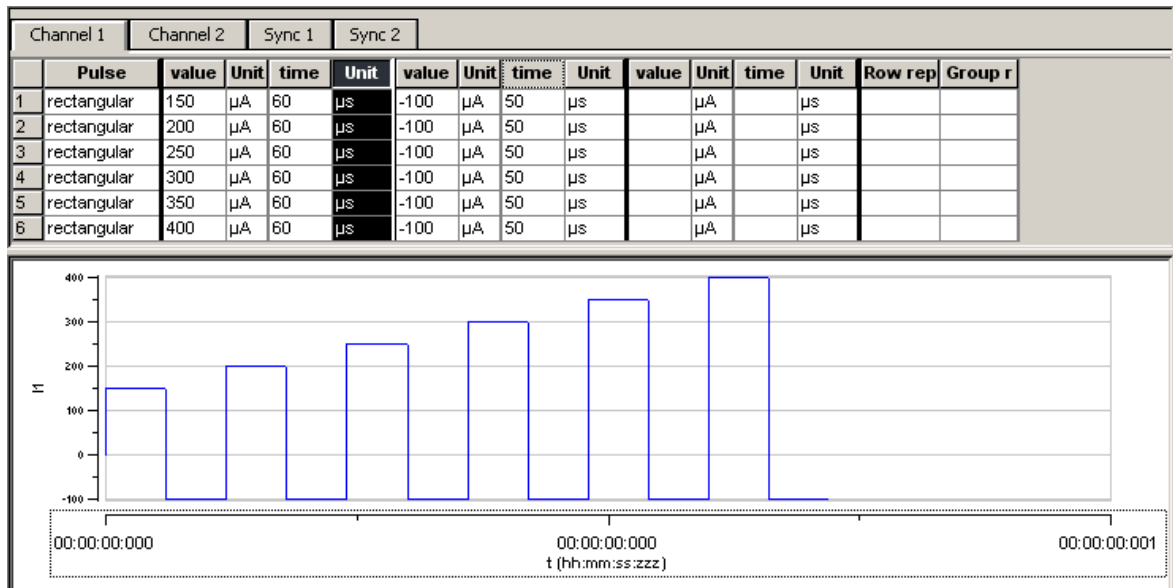

### Shifting absolute time or voltage values

With this option, the signs of the selected values are ignored. Zeros are never changed, that is, the option **Keep Zero** cannot be deselected.

1. Under **Type of Increment**, select **Absolute Value**.
2. Enter the desired shift factor.

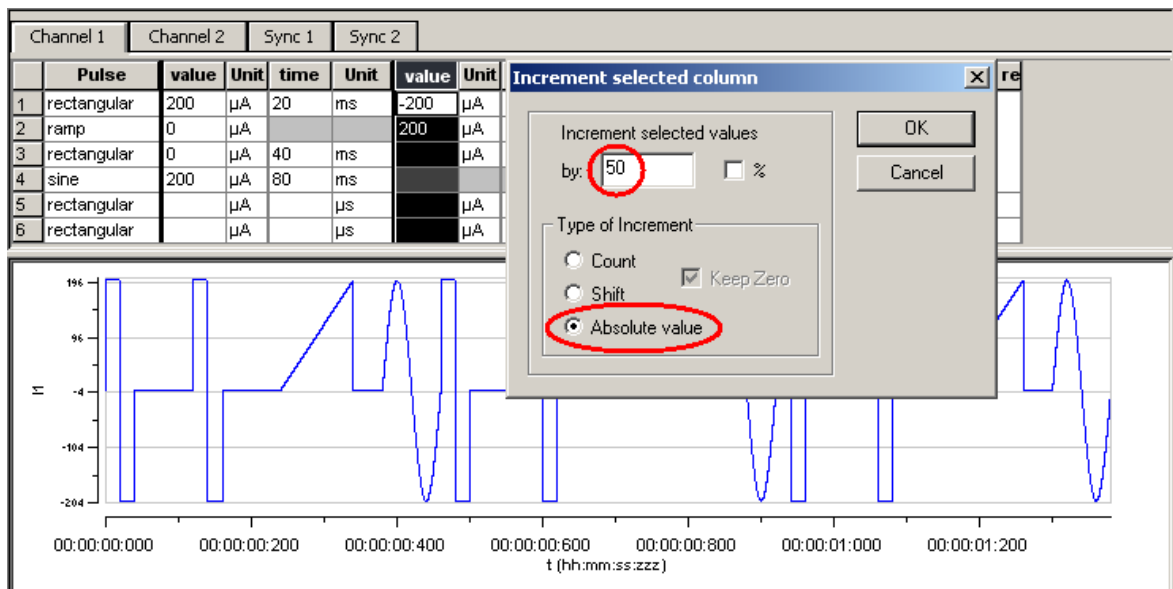

The absolute values of 200 and 200 are both 200. This absolute value of 200 is modified by the shift factor of 50, resulting in 250. The negative value is now 250, and the positive value is 250. (If you had chosen the option **Shift** instead, the computed result would have been  $200 + 50 = 150$ .) All zero values are not changed.

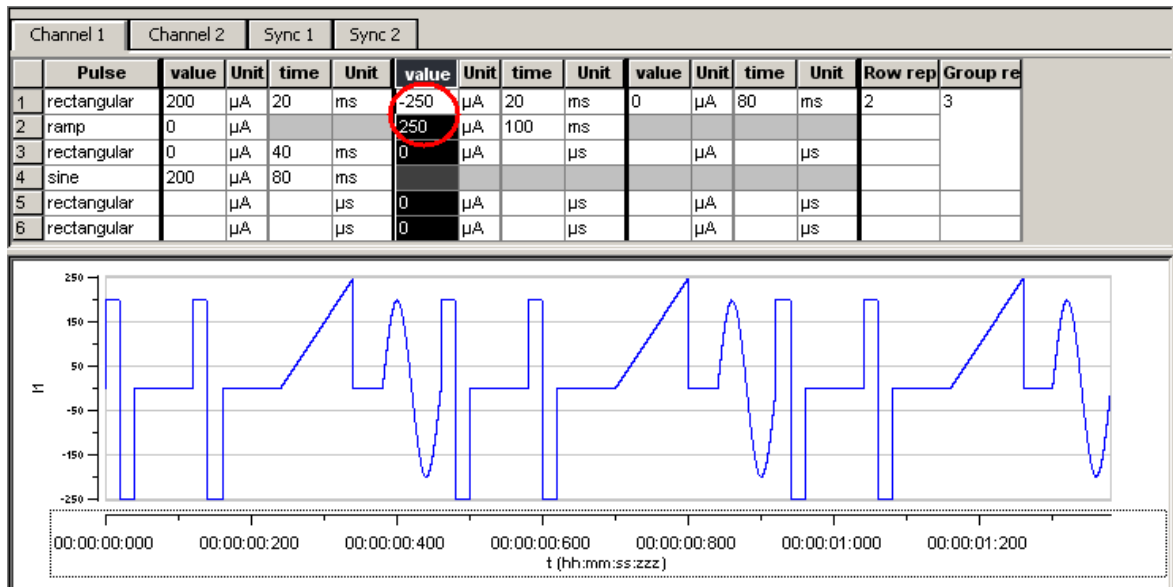

### Autocreating entries

You can use the **Autofill** feature to set up advanced time or voltage/current increments. You define the **Start** and **End** value and either the **Step Size (Start - Stop - Step Size)** or the number of **Steps (Start - Stop - # of Steps)**. Alternatively, you can enter the **Step Size** and the **Number of Steps (Start - Step Size - # of Steps)**. According to these specifications, rows are inserted and the column is filled automatically.

In the following example, the **Autofill** feature has been used to create a voltage step series from 20 mV to 500 mV with an increment of 20 mV.

1. Click any **Value** or **Time** column header to select a column. The selected column is highlighted in black.
2. Right-click and click **Autofill**.

- Select one out of three commands and fill in the white text boxes.

The screenshot shows a software interface with a table of pulse parameters and an 'Autofill' dialog box. The table has columns for Pulse, value, Unit, time, Unit, value, and Unit. The 'Autofill' dialog box has a dropdown menu set to 'Start - Stop - Step Size' and input fields for Start Value (20), Stop Value (500), Step Size (20), and # of Steps (0). The Start Value, Stop Value, and Step Size fields are circled in red.

Pulse	value	Unit	time	Unit	value	Unit
1	rectangular					
2	rectangular	$\mu\text{A}$		$\mu\text{s}$		$\mu\text{A}$
3	rectangular	$\mu\text{A}$		$\mu\text{s}$		$\mu\text{A}$
4	rectangular	$\mu\text{A}$		$\mu\text{s}$		$\mu\text{A}$
5	rectangular	$\mu\text{A}$		$\mu\text{s}$		$\mu\text{A}$
6	rectangular	$\mu\text{A}$		$\mu\text{s}$		$\mu\text{A}$

The column is filled according to the specifications.

The screenshot shows the software interface with the table and graph updated. The table now has values filled in for the 'value' and 'Unit' columns. The graph shows a series of rectangular pulses with increasing amplitude over time.

Pulse	value	Unit	time	Unit	value	Unit	time	Unit	value	Unit	time	Unit	Row rep	Group r	
1	rectangular	0	$\mu\text{A}$	40	$\mu\text{s}$	20	$\mu\text{A}$	40	$\mu\text{s}$		$\mu\text{A}$		$\mu\text{s}$		
2	rectangular	0	$\mu\text{A}$	40	$\mu\text{s}$	40	$\mu\text{A}$	40	$\mu\text{s}$		$\mu\text{A}$		$\mu\text{s}$		
3	rectangular	0	$\mu\text{A}$	40	$\mu\text{s}$	60	$\mu\text{A}$	40	$\mu\text{s}$		$\mu\text{A}$		$\mu\text{s}$		
4	rectangular	0	$\mu\text{A}$	40	$\mu\text{s}$	80	$\mu\text{A}$	40	$\mu\text{s}$		$\mu\text{A}$		$\mu\text{s}$		
5	rectangular	0	$\mu\text{A}$	40	$\mu\text{s}$	100	$\mu\text{A}$	40	$\mu\text{s}$		$\mu\text{A}$		$\mu\text{s}$		
6	rectangular	0	$\mu\text{A}$	40	$\mu\text{s}$	120	$\mu\text{A}$	40	$\mu\text{s}$		$\mu\text{A}$		$\mu\text{s}$		

## 5.8 Auto Sync for Autocreating Trigger Pulses

If you want to synchronize other devices, for example, a MEA1060-BC amplifier, the MC\_Card or an USB data acquisition device with the stimulus generator, you have to set up the digital output of the Sync Out channels in synchrony to the stimulus pulses. This may sometimes be a bit tricky and time consuming, especially for complex stimulus protocols.

The **Auto Sync** feature is intended for making the work with MC\_Stimulus more efficient: Digital Sync Out TTL pulses synchronous to stimulus pulses are generated automatically by this feature. Each time an analog channel generates a pulse (that is, its value is not equal to zero), the logical state of the assigned Sync Out channel is set to HIGH (=1). You can set the **time offset** of the TTL's rising edge **before** the stimulus pulse and of the TTL's falling edge **after** the pulse. If you change the stimulus protocol, corresponding **Auto Sync** pulses are updated on the fly. This feature is especially recommended for controlling the MEA1060-BC amplifier with superior stimulus artifact suppression.

On the **Edit** menu, click **Auto Sync Settings**. The **Auto Sync Settings** dialog box appears.

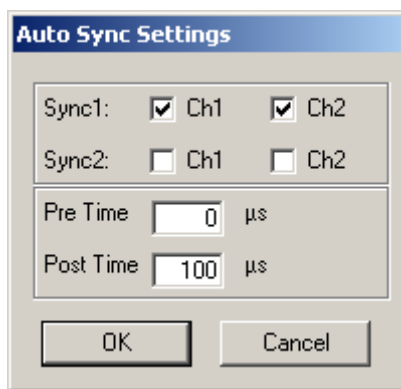

Assign the analog stimulus channels that will be used as the basis for autocreating the protocols on the Sync Out channels 1 and 2. For example, if you use only stimulus channel 1, select **Ch1** under **Sync1**. If you use a MEA1060-BC amplifier, you can use up to two output channels per amplifier, that is, you may want to select **Ch1** and **Ch2** for **Sync1**. The preceding screen shot shows an advanced setup that could be used, for example, for a setup with 4 MEA1060-BC amplifiers, each connected with two analog STG channels and one Sync Out.

Set the time offset of the TTL's rising edge **before** the stimulus pulse (**Pre Time**) and of the TTL's falling edge **after** the pulse (**Post Time**). For operating a MEA1060-BC amplifier, a **Pre Time** of 0  $\mu\text{s}$  and a **Post Time** of 100  $\mu\text{s}$  are default, but especially the **Post Time** may have to be adjusted according to your stimulus amplitude and the stimulus artifact suppression performance (please see the user manual of your MEA1060-BC amplifier or the MEA\_Select help for more details).



On the **Settings** menu, click **Auto Sync** to enable the **Auto Sync** feature. The Sync Out protocols will be autocreated in synchrony with the pulse protocols on the assigned channels, will show up in the **WYSIWYG window** immediately, and will be downloaded onto the STG with your next download. (Please make sure that the display and download options are appropriate, that is, all necessary Sync Out channels are selected.) The **worksheets** of the Sync Out channels assigned to the **Auto Sync** feature will be **unavailable**, that is, you cannot edit them manually. The following screen shot shows an example of a monophasic 100  $\mu$ s voltage pulse on channel 1 and the corresponding Auto Sync pulse (Pre Time 0  $\mu$ s, Post Time 100  $\mu$ s) on Sync Out 1.

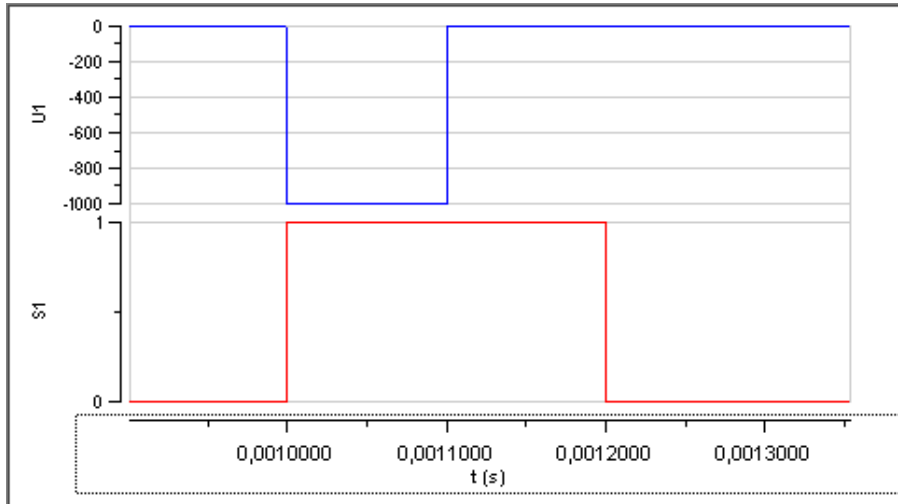

If you later choose to edit the Sync Out worksheets of the active file manually, you can deselect the **Auto Sync** feature on the **Settings** menu. Any information in the Sync Out worksheets that was there **before** the **Auto Sync** option was enabled will be **restored**; and all worksheets will be available for manual editing.

## 5.9 Adjusting the Stimulus Intensity Level

After having programmed the stimulus protocol, you can either download the protocol "as is", or you can adjust the **stimulus intensity level**, that is, choose a percentage (from 0 to 200 percent) of the programmed amplitudes, independently for both channels. You can adjust the level **offline** and **download** the information onto the stimulus generator manually afterward, or you can adjust the level **on-the-fly**, without stopping the running stimulation. This feature is especially convenient for testing out thresholds that evoke a biological response.

**Note:** The **error messages** that are displayed when the stimulus amplitude is not set to zero at the end of the protocol or when the time length of stimulus protocols is different on individual channels can present a nuisance when adjusting the level on-the-fly. These error messages can be switched off by deselecting the option **Enable Compiler Warnings** on the **Settings** menu.

1. On the **Edit** menu, click **Amplitude**. The **Amplitude** dialog box opens. You can drag and drop it anywhere you like on the screen, also outside the main window of the MC\_Stimulus II program. This is especially convenient when you are using two monitors.
2. Select the option **Auto Download** if you want to adjust the stimulus intensity level **on-the-fly**. Deselect the option if you want to download the changes manually later.
3. Select the option **Change All** if you want to adjust the stimulus intensity to the **same** level on all channels. Deselect the option if you want to set individual channels to different levels.
4. Drag the slider with the mouse for adjusting the stimulus intensity in the range of **0 to 200 percent** of the programmed stimulus amplitudes. The WYSIWYG display is updated automatically. The worksheet is **not** updated. It always relates to the stimulus protocol that you programmed initially. If **Auto Download** is selected, changes are **immediately** downloaded onto the stimulator after releasing the slider, and the stimulus protocol is **restarted** from the beginning, with the adjusted stimulus intensity level.
5. If **Auto Download** was not selected, you need to download the stimulus protocol manually for changes to take place.
6. You can click the **Reset All** button to set the level on all channels back to 100 percent.

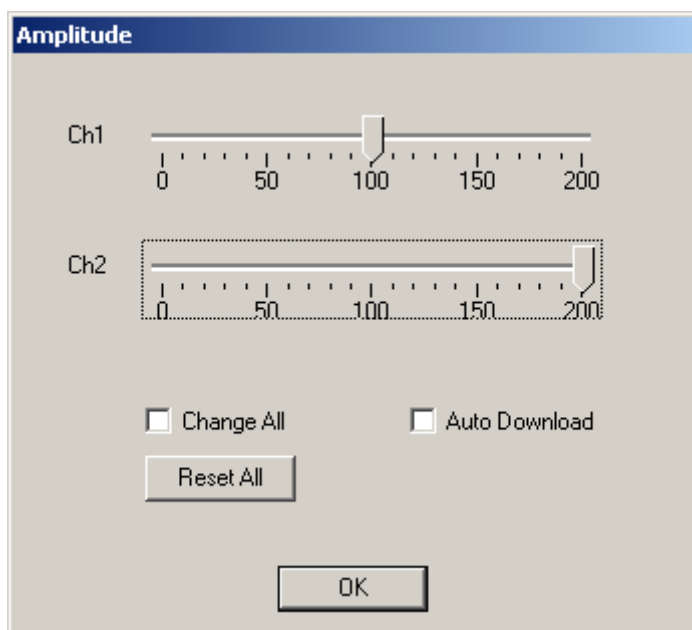

Channel 1 is set to 100 %, that is, the stimulus protocol will be downloaded onto the stimulus generator as it was programmed in the worksheet. Channel 2 is set to 200 %, that is, all stimulus amplitudes programmed on channel 2 are doubled.

## 6 ASCII Import / Export

### 6.1 Loading Files

The ASCII import filter is used to load stimulus protocols from an ASCII file into the stimulus worksheet of MC\_Stimulus II. You can use this feature for feeding recorded signals (for example, exported from MC\_Rack, see the MC\_Rack manual) into the stimulus generator. You can also export the data from MC\_Stimulus, modify it with your custom text or spreadsheet editor, and reimport it into MC\_Stimulus II.

The current version of the import filter is version 3.1.2

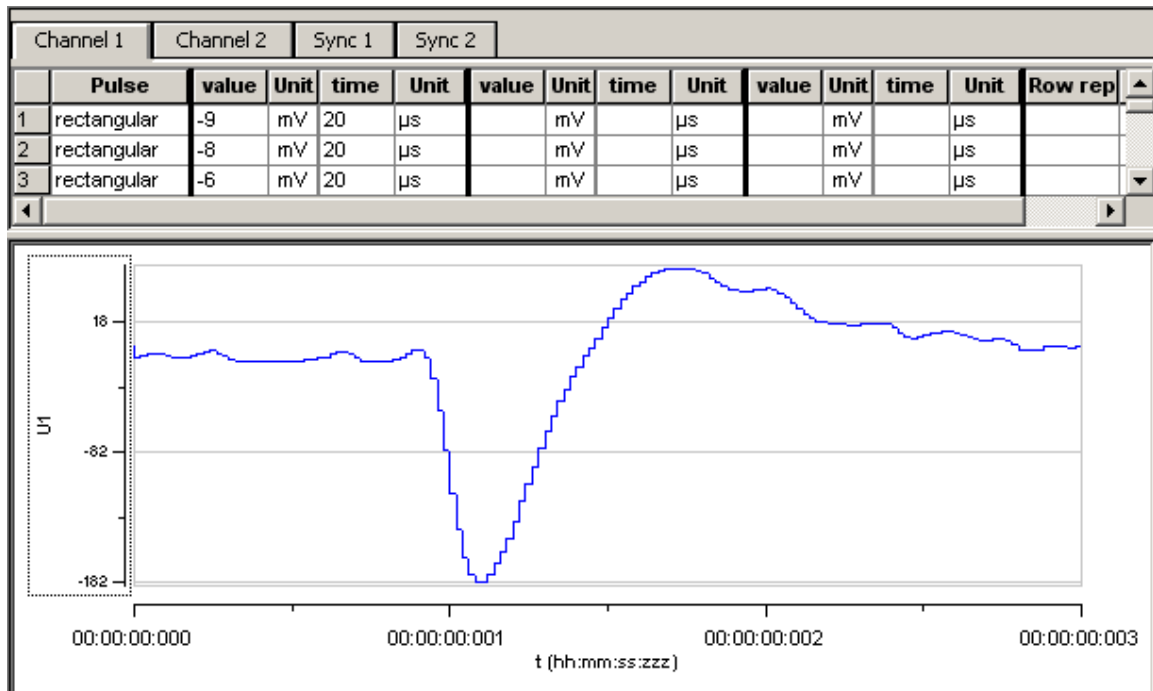

#### ASCII import example: Stimulating with biopotential waveforms

Shown is a single spike recorded from an organotypic hippocampal culture. The spike waveform was exported as ASCII from MC\_Rack and imported into the MC\_Stimulus II program.



**Warning:** All previous records in the active MC\_Stimulus II file (\*.stm) file are overwritten. Please create a new file and import the data into an empty worksheet to avoid data loss.

On the **File** menu, click **Import ASCII File**. The **Open** dialog box appears.

Select an appropriate ASCII file and click **Open**. The stimuli from the ASCII file are loaded into the active MC\_Stimulus worksheet. All previous records are overwritten. Channels that are not present in the ASCII file are empty. You can now edit and download the stimulus file as usual.

If the file does not fulfill the requirements of a stimulus file, an error message will show up and tell you in which line the first error occurs. See "Supported File Format" for more information about supported ASCII files.

## 6.2 Exporting Files

1. On the **File** menu, click **Export ASCII File**. The **Save As** dialog box appears.
2. Browse to the target folder and enter a file name.
3. Click **Save** to generate the ASCII file.

All pulse protocols from the active file will be saved in ASCII file format. The MC\_Stimulus II ASCII format type is **format type 4**. For your convenience, the generated ASCII file includes the header that is required for reimporting the file into MC\_Stimulus II.

## 6.3 Supported File Formats

The ASCII text must exactly follow the specifications below. The parameters in angle brackets are placeholders for any valid numbers or strings.

**Hint:** You can set up files conveniently in any standard spreadsheet program and save them as tab-delimited ASCII.

### General

- The **file name** and the file name **extension** are not important. You can use any extension you like, for example \*.txt, or \*.dat, or any other.
- **Comments** are introduced by the number sign #. The rest of the line after # is only for your information; it is completely ignored when executing the stimulus file. (You do not need comments, of course, but it is convenient for documentation.)

**Hint:** Use # to comment lines out. That is, you can disable lines without removing it from the file. Thus, you can keep the lines for later uses.

- Blank lines are **ignored**.
- The **spelling** is strict. The MC\_Stimulus II program does not recognize a keyword if it is misspelled or if even only one character is missing, but it is **not** case-sensitive.
- The file has the following structure.

1. File header
2. Data

### File header

The **first two** non comment lines have to be the following lines. Files for older versions of the import filter (version 1.00) can be imported with the current version as well.

```
Multi Channel Systems MC_Stimulus II
ASCII import Version 1.10
```

The **next three** lines have to be the following lines (in any order).

```
channels: <number>
output mode: <mode>
format: <format number>
```

Make sure you define the total number of channels for the used STG properly (2 channels for a STG with 2 channels), according to the **software** version. You can select the maximum number of channels during the installation of MC\_Stimulus. On the **Help** menu, click **About MC\_Stimulus II** to check your current software version.

**Example:**

You have to include the following line in the ASCII file if you have installed **MC\_Stimulus II for STG4002**.

*channels: 2*

Output mode is either voltage or current.

**Example:**

*output mode: voltage*

Six different format types are available: 1, 2, 3, 4, 5, 6.

**Example:**

*format: 3*

**Data**

Preceding the data, the output channel number has to be specified by the following line.

`channel: <channel number>`

You can specify **analog** output channels from 1 to 2 (limited by the number of analog output channels of the connected STG, of course).

The digital **Sync Out** channel number directly follows the **maximum** number of output channels. For example, if you have installed MC\_Stimulus II for 2 channels, the Sync Out channel is channel number 3.

The data follows after the channel specification line; three format types are available. All format types follow the MC\_Stimulus II worksheet's structure of rows and columns. See the description of the worksheet for more details. Columns are separated by blanks or tabs. The first line has to contain the column headers. The following lines contain the voltage/current and time values. Rows/lines are separated by a carriage return or line feed (CR / LF). This is the Windows standard control character inserted when you press the ENTER key.

The voltage unit is mV and the current unit is  $\mu\text{A}$ . Please make sure that all values are in the ranges specified for the STG you use. For the Sync Out channel, only values of 0 and 1 are allowed.

The time unit is  $\mu\text{s}$ . Time values can be in the range from 20 to 18.000.000.000 (20  $\mu\text{s}$  to 5 h). Time base of the STG is **20  $\mu\text{s}$** , so only times that are **multiples of 20  $\mu\text{s}$  are valid**.

**Note:** Please make sure that there are no additional tabs or characters, which would lead to an error message. Show tabs and spaces in your text editor and check the file before importing it.

### Format type 1

This is a basic format with two columns of **Value** and **Time** each, without **Repeat** functionality.

value    time                    value                    time

### Format type 2

With this format, you can repeat rows in the same way as described for the worksheet. Group repeat is not available.

value    time                    value                    time                    repeat

### Format type 3

This format type is available only in the current version of the import filter. It allows you to use a **third column** of **Value** and **Time**.

value    time                    value                    time                    value                    time                    repeat

### Example:

The following picture shows an ASCII stimulus file opened in a standard spreadsheet program.

	A	B	C	D	E	F	G	
1	#Demo file							
2								
3	Multi Channel Systems MC_Stimulus							
4	ASCII import Version 1.10							
5								
6	channels:	8						
7	output mode:	voltage						
8	format:	3						
9								
10	channel:	1						
11	value	time	value	time	value	time	repeat	
12	200	20000	-200	20000	0	60000	2	
13	0	40000	0	0	0	0	0	
14	200	20000	-200	20000	0	60000	2	
15	0	40000	0	0	0	0	0	
16								
17	channel:	2						
18	value	time	value	time	value	time	repeat	
19	200	20000	-200	20000	0	60000	2	
20	0	40000	0	0	0	0	0	
21	200	20000	-200	20000	0	60000	2	
22	0	40000	0	0	0	0	0	
23								

The same file would look like this in a standard text editor program. You can see the tabs, spaces, and CR / LF.

```

1 #·Demo·file
2
3 Multi·Channel·Systems·MC_Stimulus
4 ASCII·import·Version·1.10
5
6 channels:» 8
7 output·mode:» voltage
8 format:·» 3
9
10 channel:» 1
11 value» time» value» time» value» time» repeat
12 200»20000» -200» 20000» 0» 60000» 2
13 0» 40000» 0» 0» 0» 0» 0
14 200»20000» -200» 20000» 0» 60000» 2
15 0» 40000» 0» 0» 0» 0» 0
16
17 channel:» 2
18 value» time» value» time» value» time» repeat
19 200»20000» -200» 20000» 0» 60000» 2
20 0» 40000» 0» 0» 0» 0» 0
21 200»20000» -200» 20000» 0» 60000» 2
22 0» 40000» 0» 0» 0» 0» 0

```

After loading the file into the MC\_Stimulus II worksheet, you can edit and download the file as usual.

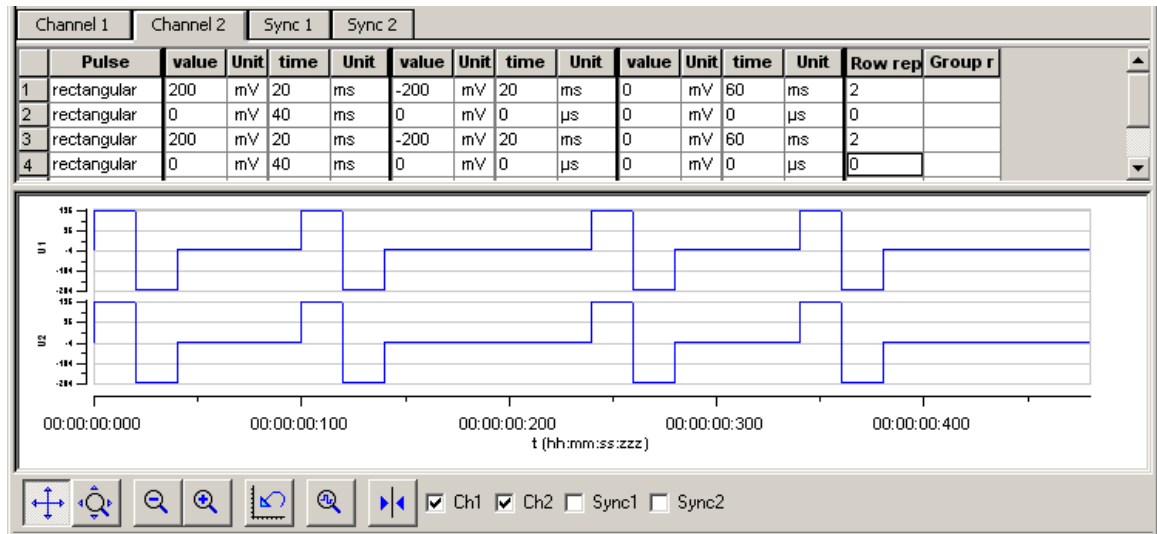

#### Format type 4

This format type is available only in the current version of the import filter. It is the plainest format with only **one column** for the **voltage / current values** and **one column** for the **time** lengths. This format is the standard format if you want to import data for example from Excel.

This format type is generated when exporting MC\_Stimulus II files as ASCII.

value time

## Format type 5

This format type is available only in the current version of the import filter. It allows you to use **ramp** and **sine** waveforms as well as **rectangular** waveforms. You specify the **Pulse** type in the first column, and the waveform in the three following columns. The general rules for setting up ramp and sine waveforms fully apply (see also Pulse Types). The pulse types are defined by the following numbers: Rectangular = 0, ramp = 1, sine = 2.

You can only use the rectangular type (0) for the Sync Out channels.

Important: When setting up **rectangular** or **sine** waveforms in this format type, you need only one value column for defining the amplitude, but you have to define both value columns even so. The **first** value column is **ignored** for rectangular and sine pulse types by the MC\_Stimulus II program.

pulse (0, 1, 2)      value      value      time

### Example:

This is an ASCII file viewed in a standard text editor program. You can see the tabs, spaces, and CR / LF.

For demonstration purposes, a ramp type pulse was programmed on the first channel, a sine wave on the second channel, a rectangular waveform on the third channel, and mixed pulse types on the fourth channel.

```
1 #.file:.example.dat
2 #.Copyright.(c).2005.Multi.Channel.Systems
3 #.this.is.an.example.file.for.MC_Stimulus.ASCII.import
4
5 Multi.Channel.Systems.MC_Stimulus
6 ASCII.import.Version.1.10
7
8 #.this.is.a.comment.line
9
10 channels:.8
11
12 output.mode:.voltage
13
14 format:.5
15
16 channel:.1
17
18 pulse» value» value» time
19 2» 0» 8000» 800000
20 2» 0» 4000» 400000
21 2» 0» 2000» 200000
22 2» 0» 1000» 100000
23
24 channel:.2
25
26 pulse» value» value» time
27 1» 0» 8000» 200000
28 1» -8000» 0» 200000
29
30 channel:.3
31
32 pulse» value» value» time
33 0» 0» 3500» 200000
34 0» 0» -3000» 200000
35
36 channel:.4
37
38 pulse» value» value» time
39 0» 0» 3500» 200000
40 1» 0» 8000» 200000
41 2» 0» 8000» 800000
42
43
```



After loading the file into the MC\_Stimulus II worksheet, you can edit and download the file as usual.

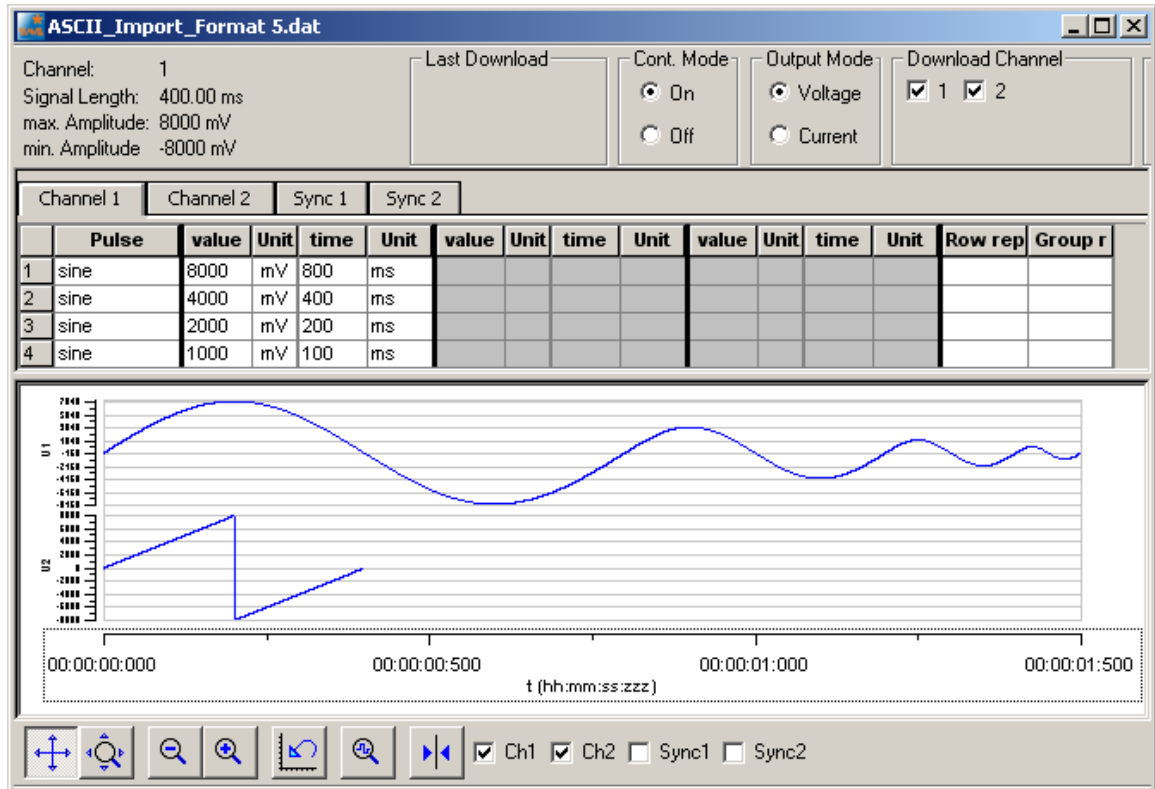

### Format type 6

Note: This file format is used by MC\_Rack ASCII export!

This format type is available only in the current version of the import filter. This is a basic format with two columns: The absolute time in seconds, and the absolute value of voltage in microvolts ( $\mu\text{V}$ ) or current in microampere ( $\mu\text{A}$ ). This file format is used by MC\_Rack ASCII export. You can directly import the MC\_Rack export files into MC\_Stimulus II.

time                    value

You can use this format with or without header.

Example:

The following picture shows a file of format type 6 without header.

```

T          elec0001 29
[ $\text{s}$ ]      [ $\mu\text{V}$ ]
0.000040  8.541667
0.000080  2.187500
0.000120  12.708333
0.000160  8.854166
0.000200  7.083333
0.000240  5.729167
0.000280  15.104167
0.000320  13.854166
0.000360  12.500000
0.000400  1.875000

```

The following picture shows a file of format type 6 with header.

```
Multi Channel Systems MC_Stimulus
ASCII import Version 1.10
```

```
channels: 8
```

```
output mode:
```

```
format: 6
```

```
channel: 1
```

time	value
[s]	[ $\mu$ V]
0.000040	8.541667
0.000080	2.187500
0.000120	12.708333
0.000160	8.854166
0.000200	7.083333
0.000240	5.729167
0.000280	15.104167
0.000320	13.854166
0.000360	12.500000
0.000400	1.875000

Using the format type 6 without header, only the first channel of the MC\_Rack raw data file can be imported.

Using the format type 6 with header you choose how many channels are imported in "channels", line 3. The output mode in line 4 has to be voltage. You choose which channel should be imported first in "channels" line 6. You can add the channels you also want to import one after the other in any order.

The value microvolt is normally used for data recording in voltage mode of MC\_Rack. The STG generates voltage pulses in values of millivolt. Please use the "Amplification" factor of the ASCII import dialog to convert  $\mu$ V in mV, otherwise the output of the STG is zero.

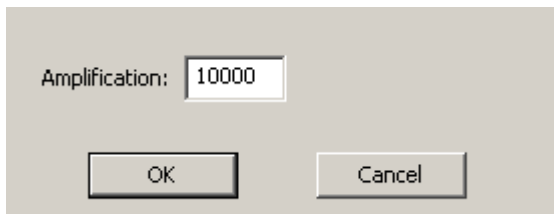

The amplification factor is generally applied in files with and without header.

## ASCII Import of Files

For ASCII import of files, please use the command **ASCII Import** in main menu "Settings".

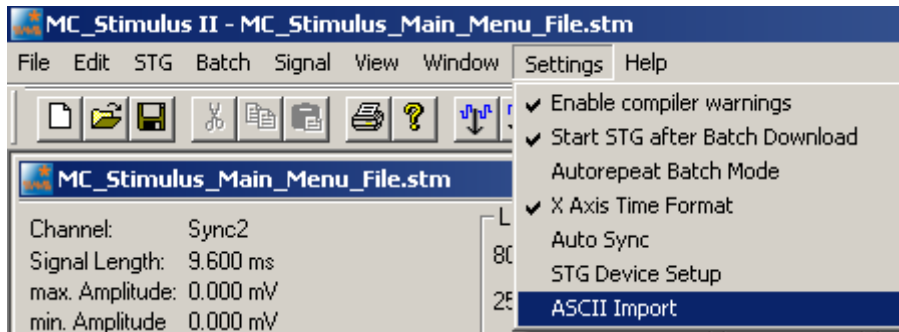

The dialog "**ASCII Import Settings**" will open.

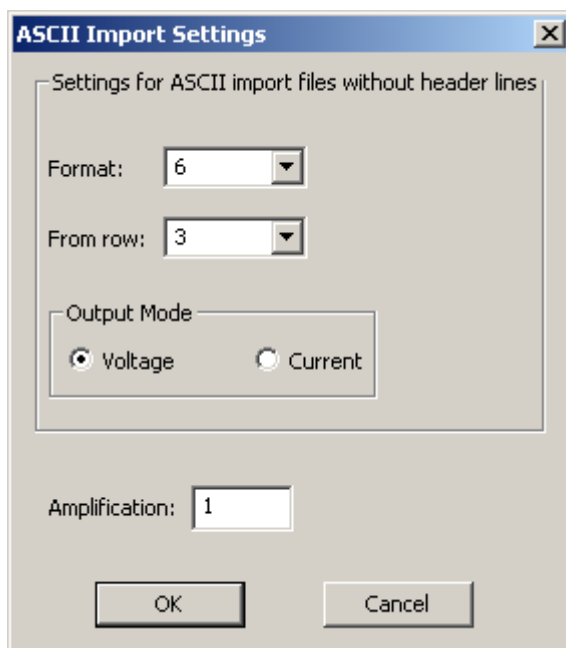

Settings for ASCII import files **without header**:

Select the format type from one to six from the drop down menu "Format".

Select the number of the row from which the file should be imported. Row numbers are available from one to ten from the drop down menu "From row".

Select the "Output Mode" in the check boxes: Voltage or Current.

Settings for ASCII import files **with or without header**:

Please choose the factor of amplification in "Amplification". This is very helpful, for example, for importing data recorded in microvolt  $\mu\text{V}$  and now needed in millivolt  $\text{mV}$ . That means, the factor is 1000 or – for higher stimulation signals - may be 10000. Please see chapter "Format Type 6" above.

**Important:** MC\_Stimulus II uses the header of an ASCII import file, if a header is available. If no header is available, MC\_Stimulus II applies the settings of the dialog "ASCII Import Setting".



## 7 Stimulus Display

### 7.1 Selecting Channels

To enlarge the display size of the channels, we suggest that you show only those channels you are currently working with.

**Note:** This will affect only the **display**. It has **no effect on the download of signals**. To select or deselect channels for downloading, click the **Download Channel** (or **Download Sync**) check boxes in the main window of the program.

Clear the check box of all channels that are not in use.

All channels that are not selected are removed from the display.

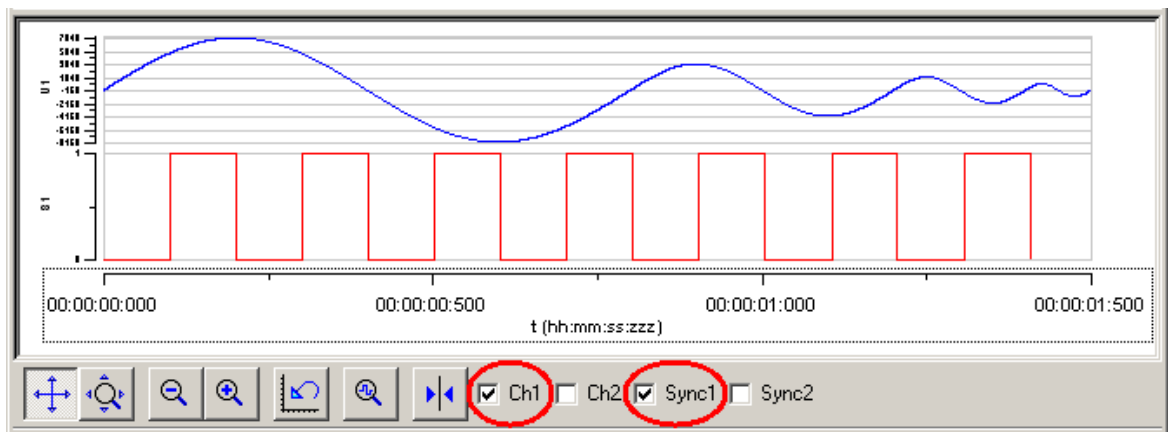

### 7.2 Display Settings







You can toggle between a **decimal time scale** in seconds (floating point numbers) and a **time of day scale** in the format hh:mm:ss:zzz, where **h** means hour, **m** is minute, **s** is second, and **z** is millisecond.

Under **Settings**, click **X-Axis Time Format**. Select the option to enable the time of day scale. Deselect the option to switch to the decimal time scale.

## Display Tools

- Several tools are provided to optimize the graphical presentation of the stimuli. If you later choose to display channels, the axes of the new displays are set to the default values. The time axis can display only positive values.
- The y-axis of the Sync Out channels cannot be adjusted, because only values of 0 and 1 are available for these channels.



	<b>Enable scrolling</b>	Scroll the axes by clicking and dragging with your mouse.
	<b>Enable scaling</b>	Zoom the axes by clicking and dragging with your mouse.
	<b>Zoom out</b>	Reduces the time scale.
	<b>Zoom in</b>	Magnifies the time scale.
	<b>Reset</b>	Resets the axes of all channels to the default values.
	<b>Size to fit</b>	Adjusts the ranges to fit the largest displayed stimulus.
	<b>Show measure tool</b>	A horizontal bar is shown that displays the current / voltage and the time value of the intersection point. Drag the bar with the mouse.

## Scrolling the axes

You can scroll the stimuli forward and backward along the time axis, and up and down along the voltage / current axis.

1. Click  to enable the **scrolling**.
2. Click the axis you like to scroll. The mouse pointer becomes a hand.

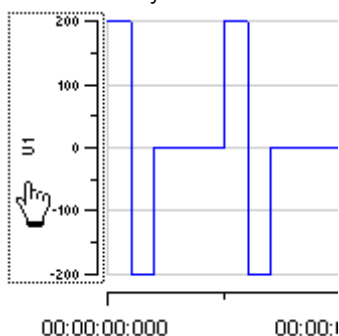

3. While holding down the mouse button, move the axis to the left and right, or up and down.  
- OR -  
You can use the keyboard: Press LEFT ARROW or DOWN ARROW to move the axis to the left (down), RIGHT ARROW or UP ARROW to move the axis to the right (up).  
- OR -  
Use the PAGE UP and PAGE DOWN keys for a faster scrolling (larger steps): PAGE DOWN to move to the left (down), PAGE UP to move to the right (up).

## Zooming the display

1. Click  to enable the **scaling**.
2. Click the axis you like to scale. The mouse pointer becomes an arrow.

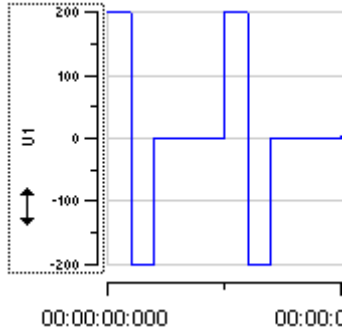

3. While holding down the mouse button, move the mouse up / right to zoom the axis in, and move the mouse down / left to zoom the axis out.  
- OR -  
You can use the keyboard: Press LEFT ARROW or DOWN ARROW to zoom the axis out, RIGHT ARROW or UP ARROW to zoom the axis in.  
- OR -  
Use the PAGE UP and PAGE DOWN keys for a faster scrolling (larger steps): PAGE DOWN to zoom out, PAGE UP to zoom in.

## Size to fit

Click  to size the display to fit. The ranges are automatically adjusted to fit the maximum amplitude of each stimulus. The range of the time axis will be set to fit the longest signal.

## 8 Downloading Stimuli

### 8.1 Downloading Stimulus Files

After having set up the stimulus file, you can download the file to the connected STG. You can **select** the channels that you want to download or download the **complete** file.



You can start the stimulation **directly** after the download, or start it **manually** with the software or hardware controls, or start it **on a trigger**. See also chapter "Operating the STG" for more information.

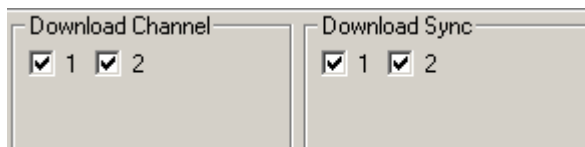

**Warning:** Check the file thoroughly before downloading it on the STG. The stimulus display is independent from the worksheet and from the download. Verify that you download **only** the channels that you want to use. Do **not** start the STG if you are not sure about the channel configuration or the nature of the downloaded file.

1. Select the channels for downloading under **Download Channel** and **Download Sync**.



2. On the **STG** menu, click **Download** or click  on the toolbar to download only the selected channels onto the STG or **Download and Start**  to download only the selected channels and start the stimulation directly after the complete download.

#### **Disable / enable warning messages**

Cancel this option to disable the message boxes displaying compiler warnings during stimulus download.

The two error messages that can be disabled are: "Warning: signal length shorter than the maximum" and "Warning: non zero last amplitude value". They may present a nuisance if you download multiple stimulus files in batch mode.

On the **Settings** menu, select or deselect **Enable Compiler Warnings**.



## 8.1.1 Download Modes

### Default Mode

When downloading files created in MC\_Stimulus II software to a stimulus generator of the STG4000 series, two different download modes are available. In "**Default Mode**", for each download all channels are stopped and cleared before the new paradigm is downloaded. All available channels are downloaded one after the other regardless of the space each channel needs, which means that the available memory is optimally used. This mode should always be used when large and complicated stimulation patterns are used, for example white noise stimulation.

The second option is to use the feature "**Independent Channel Download**" which is available in the "Settings" menu. This feature allows downloading a new stimulation paradigm to individual channels only, while all other channels continue with their former program without stopping. To enable this, the memory space of the STG is divided among all available channels. For example, when using a STG4008, the memory is divided in four parts, for two Sync Out channels and two stimulation channels, so the memory space for each channel is more limited than in default mode. If a stimulation pattern is too large for the available memory partition, no download is possible.

Note: It is recommended to operate the STG in default mode. The "Independent Channel Download" feature should only be used if one STG is connected to more than one recording system, and if those recording systems should be operated independently.

## 8.1.2 Independent Channel Download

The "**Independent Channel Download**" can be activated in the "Settings" menu. As mentioned above, it allows downloading of new paradigms to individual channels without also stopping all other channels, but also leads to limited memory availability.

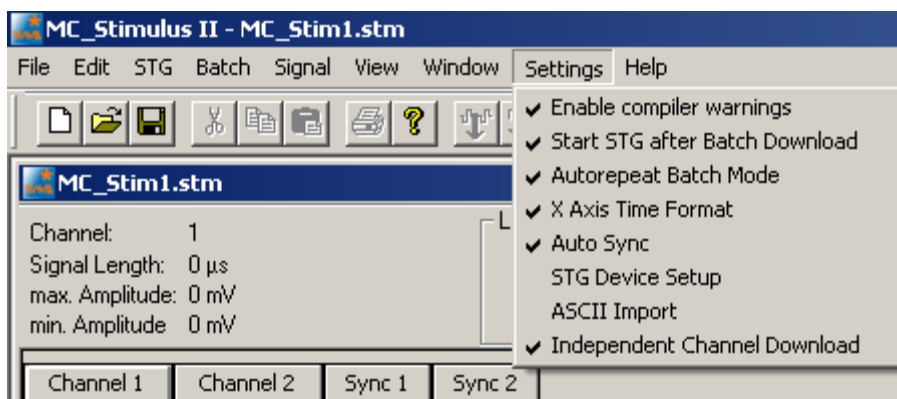

This feature is primarily intended to be used with MEA-Systems with multiple amplifiers and only a single STG. Please see chapter "Operating multiple MEA Amplifiers with one STG".

If the independent download option is active, a click on the "Download" or "Download and Start" button will only download a new paradigm to the channels selected in the "Download Channel" check box (1 and 6 in this example). Other channels will not be influenced.



However, the individual download option is influenced by the "**Trigger Settings**". To be able to download channels independently from each other, it is mandatory that these channels are assigned to different triggers. If a new paradigm is downloaded to one channel, all channels assigned to the same trigger will also be stopped, even though no new paradigm is sent to this channel.

Each time you change any parameter in the "Trigger Settings" dialog, the running stimulation will be stopped automatically. You have to start the stimulation again manually. The following dialog appears when you change anything in the "Trigger Settings" dialog. Click "Yes" button to download on all channels, click "No" button to download on selected channels.

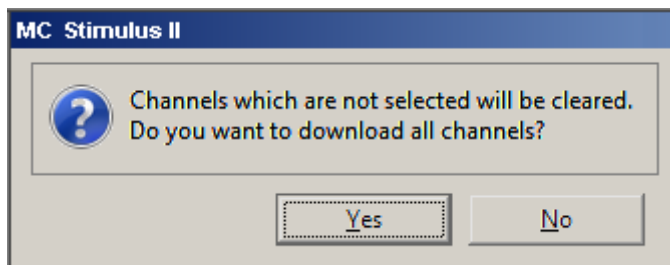

## 9 General Software Features

### 9.1 Customizing the Main Window

You can customize the size and position of open file windows and the toolbar in MC\_Stimulus II.

- You can **hide** the **toolbar** and the **status bar** by deselecting them on the **View** menu.
- You can **arrange** the **windows** with the commands on the **Window** menu.
- **Cascade**: Use this command to arrange multiple opened windows in an overlapped fashion. The windows are resized to the standard size.
- **Tile**: Use this command to arrange the windows so that they are not overlapping.
- **Arrange Icons**: Use this command to line up minimized windows.
  - You can **resize** the windows with your mouse.
  - Click an empty area on the toolbar, and then **drag** the **toolbar** to a new position.

### 9.2 Menu Bar

You will find most software features in the pull-down menus of the main window. Each menu displays a list of commands. Commands that are **not available** at the moment appear **shaded**.













#### Use the ...

- **File** menu to create new files, save files, import ASCII files, and print the stimulus worksheet.
- **Edit** menu for general editing features like copy and paste rows, remove the last entered value (**Undo**), remove and insert rows into the active worksheet. You can also **right-click** on a row and select these commands. Click **Clear Signal** to delete all values in the active worksheet. You can also specify the output ranges according to the connected STG on this menu. Please see the technical specifications of your STG.
- The **STG** menu contains all commands directly relating to the hardware, for example download commands, start and stop the STG, and trigger configurations.
- You can open, start, and stop a batch run of several files on the **Batch** menu.
- **Signal** menu for nice editing features like editing whole columns, and autcreate signals. You can also **right-click** on a column and select these commands.
- **View** and **Window** menu to customize the main window.
- **Settings** menu to define general settings of the software.
- **Help** menu to open the **MC\_Stimulus II Help** and to display the **About** dialog where you can find information about the hardware, software, and firmware versions. You will need this information when you contact the support.

## 9.3 Toolbar

For your convenience, you will find some of the more commonly used commands as a button on the toolbar.



	<b>New File</b>	Creates a new MC_Stimulus II file (*.stm) file.
	<b>Open File</b>	Opens a previously saved MC_Stimulus II file (*.stm) file.
	<b>Save File</b>	Saves a MC_Stimulus II *.stm file to the chosen destination.
	<b>Cut Row</b>	Deletes selected row(s) and sends deleted row(s) to clipboard.
	<b>Copy Row</b>	Sends selected row(s) to clipboard.
	<b>Paste Row</b>	Pastes row(s) from clipboard and overwrites row(s) starting at the selected row.
	<b>Print</b>	Prints active channel of active worksheet.
	<b>Information</b>	Opens the <b>About</b> dialog, where you can find information about the hardware, software, and firmware versions.
	<b>Download</b>	Downloads stimulation file to the connected STG (only available if the STG has active computer connection).
	<b>Download and Start</b>	Downloads and starts stimulation file to the connected STG (only available if the STG has active computer connection).
	<b>Start</b>	Starts downloaded stimulation file (only available if the STG has active computer connection).
	<b>Stop</b>	Stops downloaded stimulation file (only available if the STG has active computer connection).

## 9.4 Shortcut Keys

Shortcut keys offer you another way to accomplish common tasks. Using a shortcut key usually consists of pressing and holding one key while pressing a second key.

See the list of shortcut keys available in the software.

### Shortcut key

CTRL+C	<b>Copy Row</b>
CTRL+D	<b>Download</b>
CTRL+A	<b>Download and Start</b>
CTRL+N	<b>Create New File</b>
CTRL+O	<b>Open File</b>
CTRL+P	<b>Print</b>
CTRL+R	<b>Start</b>
CTRL+S	<b>Save file</b>
CTRL+T	<b>Stop</b>
CTRL+V	<b>Paste Row</b>
CTRL+X	<b>Cut Row</b>
CTRL+Z	<b>Undo</b>

Hint: Shortcut key combinations are also listed on the toolbar menus. For example, the **File** menu shows that the shortcut key for **Save** is **CTRL+S**.

## 9.5 File Menu

You can save MC\_Stimulus II files for later use. This is very convenient if you have various similar experimental setups, or if you like to repeat an experiment later.

### Open a file

You may open previously saved files for similar experimental setups.

1. On the **File menu** or on the toolbar, click **Open** .
2. Browse your folders and choose the desired file. You may only open MC\_Stimulus II files (\*.stm).
3. Click **Open**. The selected file opens.

### Save a file

1. On the **File** menu or on the toolbar, click **Save** . The currently active worksheet is now saved.  
You may open the file using MC\_Stimulus II later on to continue your experiment.

### Save as

Use this command to save your file under a new name, for example, if you like to use a file as a template for a new file.

1. On the **File** menu, click **Save As**.
2. Browse your folders and enter a file name.
3. Click **Save**. The current worksheet is now saved under the new name.

You may open the file using MC\_Stimulus II later on to continue your experiment.

### Import ASCII File

Please see the chapter "ASCII Import / Export".

### Export ASCII File

Please see chapter "ASCII Import / Export"

### Printing a channel

1. On the **File** menu, click **Print Setup** to select a printer, paper format, and so on.
2. Click **Print Preview** to preview the print output.
3. Click **Print**  to print out the active channel of the active worksheet.

## 9.6 Settings Menu

### Enable Compiler Warnings

Cancel this option to disable the message boxes displaying compiler warnings during stimulus download.

The two error messages that can be disabled are: "Warning: signal length shorter than the maximum" and "Warning: non zero last amplitude value". They may present a nuisance if you download multiple stimulus files in batch mode, or if you want to adjust the stimulus intensity level on the fly.

On the **Settings** menu, select or deselect **Enable Compiler Warnings**.

## 10 Synchronizing Events

### 10.1 Digital Output Signals (Sync Out)

The output of the digital **Sync Out** outputs is a **3.3 V TTL** signal. A logic state of **1** means 3.3 V, and a logic state of **0** means 0 V. Please note that the digital output is about **15 µs faster** than the analog output. This small offset is generally sufficient to make sure that the Sync Out signal precedes the stimulation, which is important for synchronizing events.

You can program the output signal of the Sync Out channels in the same way as the analog output signals, but due to the nature of a digital signal, only values of 0 and 1 are allowed. A Sync Out signal is generated each time when the STG is started.

The output signal can be used for triggering external devices, for example, the data acquisition with the **MC\_Card** of the **ME-System** and the **MEA-System**. Please note that if you use it for triggering the MC\_Card, you should use output signals that have a duration of at least 200 µs. Otherwise, it can happen that the MC\_Card ignores trigger events.

All available Sync Out outputs are active when the STG is started by pressing the **Start / Stop** button, or by using the software command **Start** on the **STG** menu.

If you are using the **Trigger In inputs** for starting the STG, each of the **Sync Out** channels is controlled by a **separate** Trigger In channel. **Sync Out 1** is active when **Trigger In 1** is triggered, **Sync Out 2** is active when **Trigger In 2** is active. The assignment of Sync Out channels to Trigger In inputs can be customized, please see chapter "Trigger Settings".

If you use the **Repeat** feature in the **Trigger Settings** dialog box, the corresponding Sync Out signal is repeated as well as the selected analog output signals.

You can, for example, synchronize separate displays or other virtual instruments in MC\_Rack, one for each trigger input. You can also define a bit pattern in the **Trigger Detector** and trigger instruments on this bit pattern, for example to activate virtual instruments only when trigger 1 and 2 are active at the same time. Please see the MC\_Rack help or manual for more information on the **Trigger Detector** and triggering.

**Note:** No Sync Out signal is sent when the STG is stopped on a trigger event or by pressing the **Start / Stop** button, that is, if the trigger event occurs or the button is pressed when the STG has still been active.

#### Timing of blanking signal

If you have a MEA amplifier with **blanking circuit** in use, you can apply a blanking signal (TTL pulse) for transiently switching off the input stage of the amplifiers during the stimulus, thus avoiding the stimulus artifact.

MCS recommends a minimum blanking pulse that starts with the stimulus and **stops 100 µs after** the stimulus. The fact that the digital output of the stimulus generator from MCS is about **15 µs faster** than the analog output ensures that the blanking signal is delivered before the stimulus. It is very important that the blanking pulse is delivered shortly before the stimulus.

The following example shows a blanking signal (programmed with MC\_Stimulus II) of 300  $\mu\text{s}$  length for a biphasic pulse of 200  $\mu\text{s}$  length. See also the "MEA\_Select Help or the MEA Amplifier with Blanking Circuit" manual for more information.

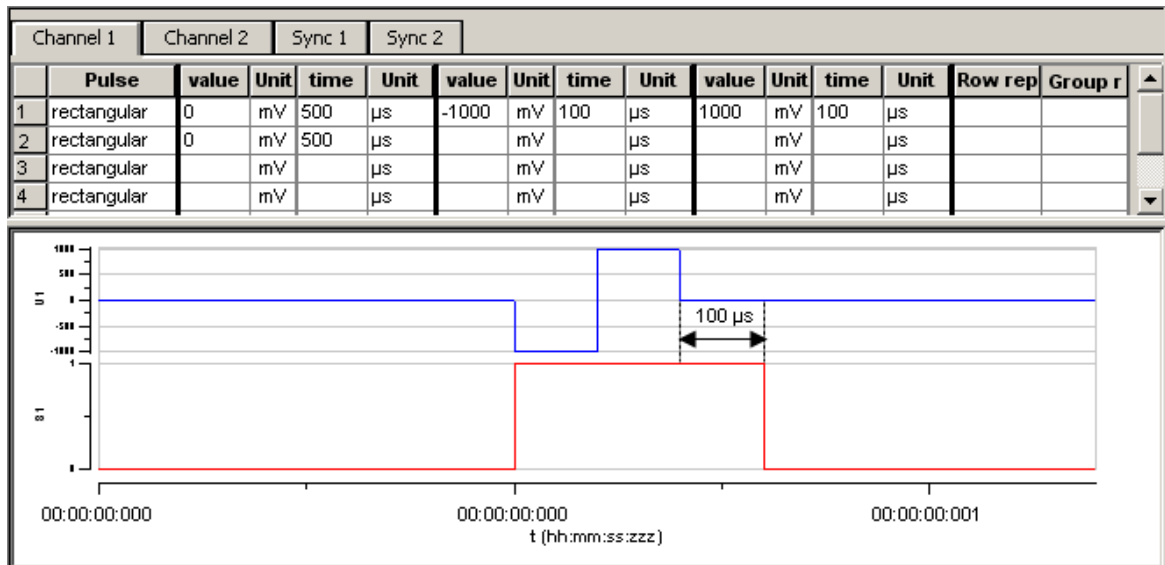

You can use the Auto Sync feature for autocreating the Sync Out pulses without entering values manually. Please see "Auto Sync for Autocreating Synchronous Sync Out Pulses".

## 10.2 Triggering Stimulation (Trigger In)

The external trigger input has to be a **TTL signal** of at least  **$40 \pm 10 \mu\text{s}$**  length. TTL pulses shorter than that may not be recognized by the stimulus generator.

A TTL pulse is defined as a digital signal for communication between two devices. A voltage between 0 V and 0.8 V is considered as a logical state of 0 (LOW), and a voltage between 2 V and 3.3 V means 1 (HIGH). It is the same kind of signal as the output signal of the **Sync Out** output of the STG.

The **rising edge** of the **HIGH** trigger input starts and stops the STG. The time lag between the rising edge of the **TTL input** and the **stimulus output** is  **$30 \pm 10 \mu\text{s}$** . The minimum distance between two trigger inputs is  **$100 \mu\text{s}$** , resulting in a **maximum trigger frequency of 10 kHz**. If a higher frequency is used, the stimulus generator is likely to miss trigger inputs. See the illustration below for more details on the timing. Please note that the **digital Sync Out** output is about  **$15 \mu\text{s}$  faster** than the **analog** outputs. See chapter "Digital Output Signal (Sync Out)" for more information.

You can either trigger separate output channels (**Standard** mode) or separate MC\_Stimulus II files (**Multi-File** mode).

There is also one separate **Sync Out** output for each trigger input. You can assign the Sync Outs to the trigger inputs in the **Trigger Settings** dialog box. The default settings are that Sync Out 1 is active when Trigger In 1 is triggered, Sync Out 2 is active when Trigger In 2 is active. See also "Digital Output Signals" for more information on the Sync Out channels.



The **Sweep** status display (LED Start / Stop buttons) in the main window  of the program shows active sweeps that were started by the triggers. That means, the status lamp that corresponds to trigger 1 lights red as long as any channel triggered by trigger 1 is active. Please note that the number of the analog output channel is irrelevant, the **Sweep** status lamp refers only to the trigger number. Example: Assume that **channel 2** is assigned to **trigger 1**. When channel 2 is active, the **first Sweep** lamp lights red, because the first **Sweep** lamp refers to trigger 1.

You can start and stop the trigger manually at any time using the LED Start / Stop buttons.

#### Timing limits

Stimulus output

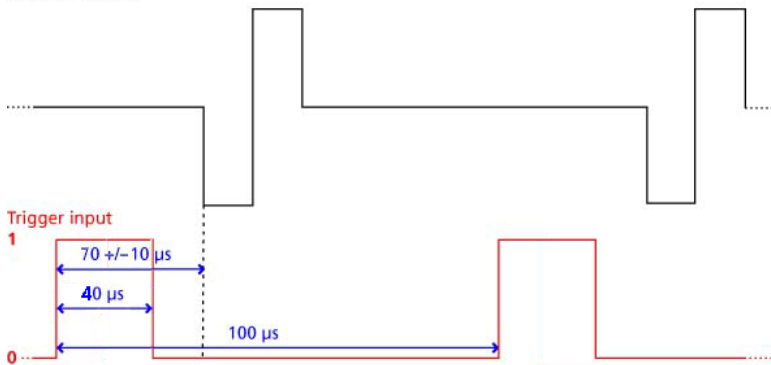

#### Custom switch for "remote-controlling" of the STG

You can connect any device that produces TTL outputs to the **Trigger In** connector of the STG, for example a switch. For example, you can use a trigger for remote controlling the STG if it is not within reach during an experiment. It is also possible to set up advanced experiments where stimulation depends on preceding activities of the studied object.

The following picture shows a suggested circuit diagram for a switch used for remote controlling. The resistor and capacitor work as a low-pass filter on the TTL signal and are necessary to reduce ringing of the signal.

#### Suggested switch for triggering the STG

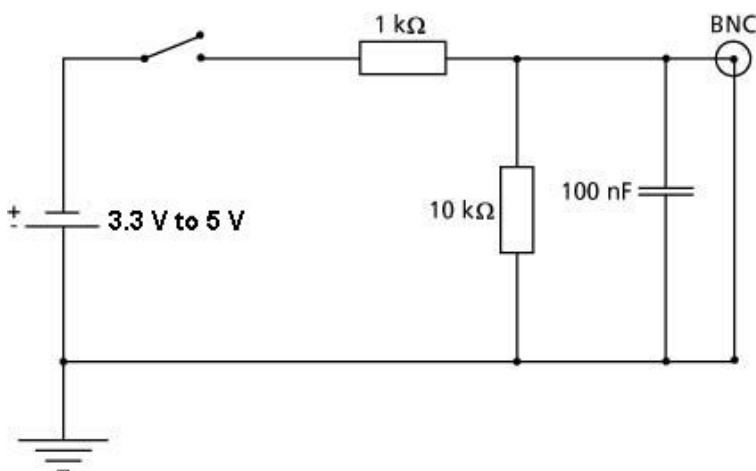

## 10.3 Trigger Settings

### Triggering output channels (Standard mode)

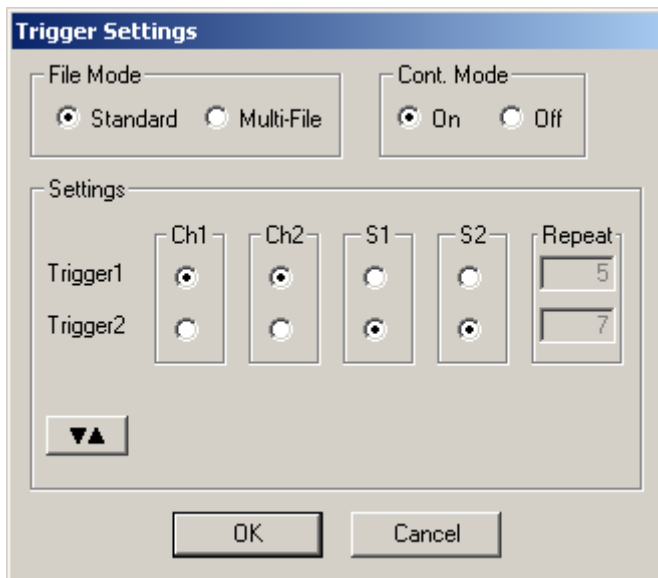

In the preceding example, trigger input 1 is used to trigger the output channel 1 and 2. This means, each time a TTL pulse is applied to Trigger In 1, stimulation on channels 1 and 2 is started simultaneously. The complete protocols of these two channels would be executed five times after the trigger event, if continuous mode would be off. However, as continuous mode is activated, trigger repeats are disabled and the protocols will be repeated indefinitely, until a manual stop occurs.

**Important:** Only channels assigned to the same trigger have the same time base. Between channels assigned to different triggers, time shifts in the order of the STGs time resolution (20  $\mu$ s) may occur.

The Sync Out outputs are assigned to their default trigger inputs, that is, Sync Out 1 is active when trigger 1 is active. You can change this assignment with the option buttons, for example, assign multiple Sync Outs to the same trigger.

The **Sweep** status light (LED Start / Stop buttons) indicates the trigger numbers that have been assigned to active channels.

Example: If channels 1 and 2 are assigned to trigger 1, and trigger 1 is started (either by the software controls, the **Start** button on the stimulus generator's front panel, or the trigger input 1), the first **Sweep** status lamp indicates the active state of channel 1 or 2, even if one of the two channels has a shorter output sweep than the other and is not active anymore.

### Triggered action when channel(s) still active

You can define what action should be taken when any of the channels assigned to the trigger are still active. Please click the expand button  to show the advanced options:

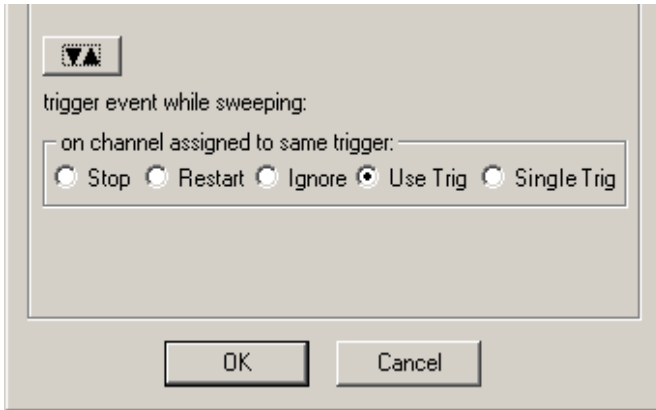

**Stop:** A following trigger input **stops** the stimulation on the assigned channels if at least one channel that has been assigned to this particular trigger is still active in the moment of the trigger event. The trigger event starts stimulation only if **no** channel that has been assigned to this trigger is active.

**Restart:** The stimulus protocols on all channels assigned to this trigger are **started** at the trigger event, regardless of the activity on these channels.

**Ignore:** The trigger event is **ignored** when any channel assigned to this trigger is active. The trigger event starts stimulation only if **no** channel that has been assigned to this trigger is active.

### Use Trigger as Gate

Channels associated with a Trigger input will be active as long as the condition of that trigger is 1 (HIGH) and switched off as soon as the condition becomes 0 (LOW). If the stimulation protocol is **shorter** than the gate, it will stop at the predefined time, regardless of the gating trigger. If the stimulation protocol is **longer** than the gating trigger, stimulation will stop when the gating trigger ends. For example, if you want to produce a repeated rectangular pulses that last as long as the gating trigger is HIGH, you can do the following: Program a single rectangular pulse and activate the continuous mode. The pulses will start as soon as the gating trigger becomes HIGH, and stop as soon as the gating trigger becomes LOW. If the voltage of the stimulation channel is different from 0 at the time the gating trigger ends, the channel will be switched off immediately. If you **stop** the stimulating protocol **manually** during the gating trigger in HIGH, stimulation is stopped but immediately restarted, and goes on until the gating trigger ends.



Warning: Once selected, this setting will become the default setting for all opened files, until unselected. So if you observe unexpected behaviour when triggering the STG, check the Trigger settings.

## Single Trigger

Important: This feature is available only with STG 4000 series. The MC\_Stimulus II version 3.2.3 (or later) with firmware update must be installed.

Additional to the general trigger states "running" and "stopped" each trigger can now be set up in a new state, called "armed". That means, the trigger is ready to start the stimulus protocol, but waiting for an external signal from the rear panel trigger inputs to execute the stimulus protocol one time only. In armed" state, the "Sweep" LED on the front panel of the STG will light up in blue, but the brightness of the LED is not as brilliant as in "running" state.

Select "Single Trigger" if you want to start the stimulus protocol once via external trigger.

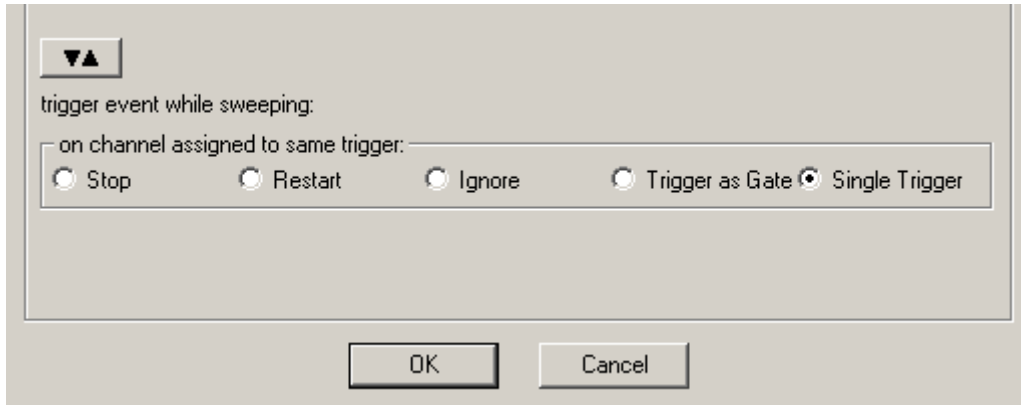

Set up your stimuli with the MC\_Stimulus II program. Download the stimulus protocol from a MC\_Stimulus II file to the STG. Arm the STG either manually by pressing the Start / Stop button on the front panel, or with software controls. To arm the STG via software, use the start icon in

MC\_Stimulus II main menu, or click the combined LED / Start / Stop button  for the "Sweeps". When armed, the STG accepts one single trigger on its trigger input. The trigger input must be connected to the device which generates the trigger. To start the stimulus protocol a second time, the STG needs to be armed again manually. As long as the STG is armed, the LED in MC\_Stimulus II appears blue to indicate the armed state.

The stimulation will automatically be started after applying the single trigger from the external device. The LED in will turn to red while the trigger is running and return to grey after the trigger has finished the stimulus protocol. The STG needs to be armed again to accept the next trigger.

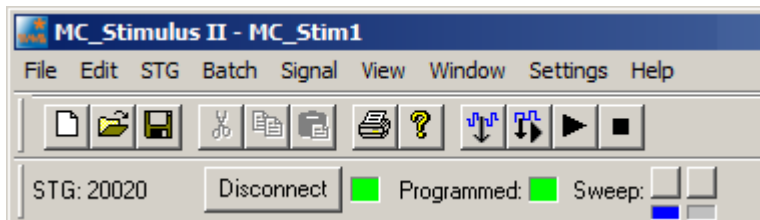

It is possible to stop the stimulation at any time while the STG is armed or is running via Start / Stop button on the front panel of the STG or via software.

## Sweep Count

The number of sweeps are counted and displayed for each of the triggers at the bottom of the main window.



Please note that **not the number of stimuli** but the number of sweeps is counted, whereby one sweep is defined as one complete run of the programmed stimulation pattern, as displayed in the main window. So, if five stimuli are programmed, and the repeat rate in the Trigger Setting menu is set to six, 30 stimuli will be delivered but the sweep count will be six.

Sweeps are **not counted online**, the final number is displayed after the STG has been stopped. The number of sweeps per channel is **not put to zero** automatically every time the stimulation is started. Instead, a reset only happens if a trigger is again used in the new stimulation. So, if a stimulation file uses trigger one and two with a repeat of three each, the display will show 1:3 2:3 3:0 4:0 at the **end of the stimulation**. If afterwards, for example a stimulation file is started which uses only trigger in continuous mode, and this file is stopped after 15 repeats of the programmed stimulation pattern, the display will show 1:3 2:3 3:0 4:15.

## 10.4 Multi File Mode

As an alternative to triggering separate channels in a single stimulus protocol, you can also trigger up to two separate stimulus files in the **Multi-File** mode. This feature allows you to trigger different stimulus protocols on overlapping channels. For example, you can control stimulus pattern A by trigger 1 on channels 1 and 2, and stimulus pattern B by trigger 2 on channels 2.

The **Multi-File** mode is indicated in the MC\_Stimulus status control bar in the main window. If you use the **Multi-File** mode, you cannot use the trigger inputs anymore for triggering single channels. When you start the download, both selected stimulus files are downloaded onto the stimulus generator. When **Trigger In 1** is active, the file assigned to **Trigger 1** is started (with all downloaded output channels); when **Trigger In 2** is active, the file assigned to **Trigger 2** is started. You can choose what action should be taken when a trigger event occurs during the time when the assigned file is still playing.

If the STG is started by the **START / STOP** button on the front panel or the **Start** command of MC\_Stimulus II, only the first / top selected file (this is usually the file assigned to trigger 1) in the **Trigger Settings** dialog box is started. (For downloading and starting multiple files without triggering, please use the **Batch** Mode.)

**Important:** As long as you are in the **Multi-File** mode, the **Standard** trigger settings (trigger inputs assigned to single channels) will have no effect. You also cannot close files if you are in **Multi-File** mode. Please leave the **Multi-File** mode by selecting **Standard** under **Mode** in the **Trigger Settings** dialog box to use the standard trigger settings or before closing files.

Please read also chapter "Extended Multi File Mode".

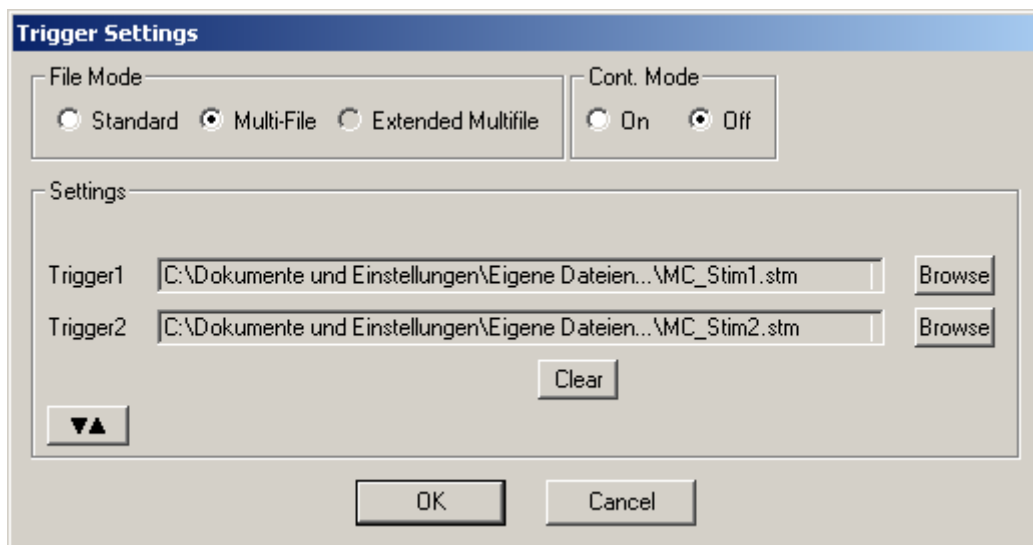

1. Connect all necessary trigger inputs to TTL signal sources.
2. Set up your stimulus protocols and save the files.
3. On the **Edit** menu, click **Trigger Settings**.
4. Select the option **Multi-File**.
5. Under **Trigger 1**, click **Browse** and select the appropriate stimulus protocol that you want to assign to trigger 1.
6. Repeat step 5 for both trigger inputs. Confirm the settings by clicking OK.
7. All selected files are opened automatically.

8. Check all stimulus protocols before download. Please make sure that you have selected all necessary channels under **Download Channel** for each file separately.
9. Download the files onto the STG by clicking **Download** on the **STG** menu.
10. The stimulation as specified in the selected MC\_Stimulus files will now be triggered by the selected trigger inputs.

### Triggered action when channel(s) still active

You can define what action should be taken when any of the channels assigned to the trigger are still active. In addition, you can also define what action should be taken when any of the channels **not** assigned to the trigger event are still active. Please click the expand button  to show the advanced options:

- **Stop:** A following trigger input **stops** the stimulation on the assigned channels if at least one channel that has been assigned to this particular trigger is still active in the moment of the trigger event. The trigger event starts stimulation only if **no** channel that has been assigned to this trigger is active.
- **Restart:** The stimulus protocols on all channels assigned to this trigger are **started** at the trigger event, regardless of the activity on these channels.
- **Ignore:** The trigger event is **ignored** when any channel assigned to this trigger is active. The trigger event starts stimulation only if **no** channel that has been assigned to this trigger is active.

*Example:*

**File A** is assigned to **trigger 1** and **file B** to **trigger 2**. Consider the following two situations:

- **Trigger 1** is **activated**, but channel 2 in file A is still active. As channel 2 from file A is assigned to trigger 1, the settings defined for "**on channel assigned to same trigger**" would be applicable.
- Trigger 1 is active, but channel 2 in file B is still active. As channel 2 from **file B** is assigned to trigger 2, the settings defined for "**on channel assigned to other trigger**" would be applicable.

## 10.5 Batch Mode

You can download and run several stimulus files one after the other in the **Batch** mode. The first file in the list is downloaded and started directly after the download, or started manually with the software or hardware controls, or started on a trigger. After the first file has been run, the second file in the list is downloaded, and so on.

### Triggering a sequence of stimulation protocols

The **Batch** mode is useful if you want to start a **sequence** of **different** stimulation protocols one after the other on the **same** trigger (Trigger 1). Please make sure that you have assigned all channels to Trigger 1 in the **Trigger Settings** dialog box. You set up the protocols and save them as separate stimulus files. Then, you set up a batch file with a list of the desired stimulus files.

- The first trigger event starts the first file in the list.
- When a file has been **completed**, the next file in the list is downloaded automatically.
- When a trigger event occurs **after** the file has been run, the next file is started.
- When a trigger event occurs **during** the run of a file, the run is stopped, and the next file in the list is downloaded. The next trigger event **starts** the next file.
- Deselect the option **Start STG after Batch Download** on the **Settings** menu if you want to start the protocols **on a trigger** or **manually** with the software or hardware controls. If the option **Start STG after Batch Download** on the **Settings** menu is selected, the STG starts each file **directly** after the download without waiting for a trigger event.

As an alternative to the **Batch** mode, you can also use **separate** trigger inputs to trigger **separate** output **channels** or **separate stimulus files**. This way, you can trigger both different pulse protocols on separate channels. See chapter "Triggering Stimulation" for more details.

**Note:** Only **Trigger 1** is available for triggering in **Batch** mode. Do not use any other trigger input.

### Splitting up stimulation protocols to circumvent the memory limitation

If the option **Start STG after Batch Download** on the **Settings** menu is selected, the STG starts each file directly after the download, which is only useful in the (unlikely) case that you need to circumvent the memory limitation of the STG. Split up your pulse protocol into several stimulus files and run them in **Batch** mode.

### Setting up a batch file

You have to set up a batch file (.stb) first, which lists the full path of all files that you like to download as a batch. The batch file has to be exactly in the following format. This example is a batch list with three different pulse protocols. Replace the file paths with the correct path of the files of your choice.

```
Multi Channel Systems MCS MC_Stimulus
Batch Control File
Version 1.00
c:\Program Files\Multi Channel Systems\MC_Stimulus
II\BatchExample\Baseline.stm
c:\Program Files\Multi Channel Systems\MC_Stimulus
II\BatchExample\Tetanus.stm
c:\Program Files\Multi Channel Systems\MC_Stimulus
II\BatchExample\TestResponse.stm
```



## Operating the STG in Batch mode

**Important:** You can operate the STG in **Batch mode** only with a **valid computer connection**. A file in the batch list is only downloaded **after** the preceding file has been run.

1. On the **Batch** menu, click **Open** to open a batch file. The **Open** dialog box appears.
2. Browse your folders and select a valid batch file, for example the sample file TetanusBatch.stb in the MC\_Stimulus II program folder.

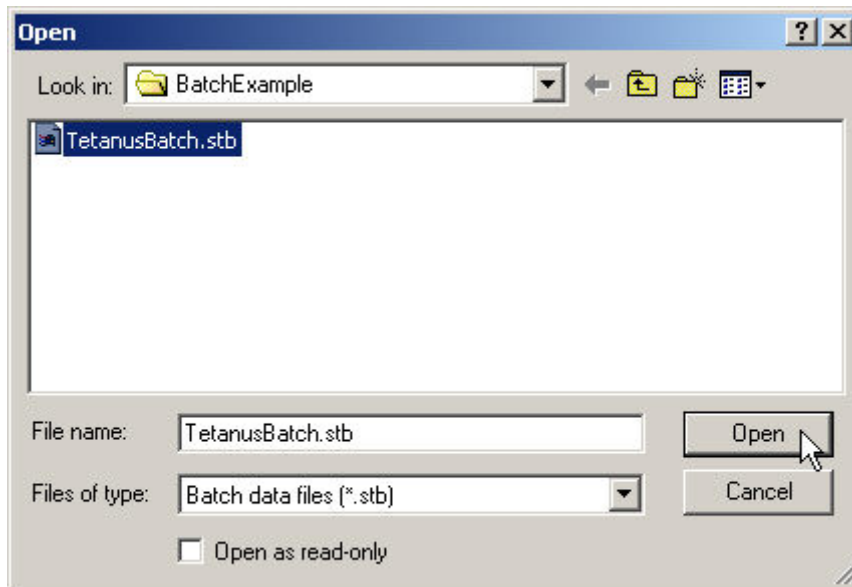

3. The **Batch Status Display** opens. It lists all stimulus files in the batch and the duration of stimulation.

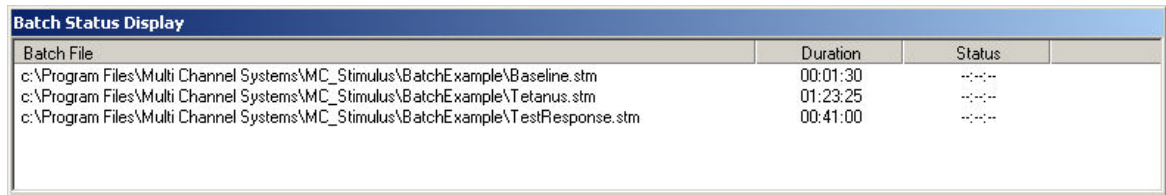

Batch File	Duration	Status
c:\Program Files\Multi Channel Systems\MC_Stimulus\BatchExample\Baseline.stm	00:01:30	--:--
c:\Program Files\Multi Channel Systems\MC_Stimulus\BatchExample\Tetanus.stm	01:23:25	--:--
c:\Program Files\Multi Channel Systems\MC_Stimulus\BatchExample\TestResponse.stm	00:41:00	--:--

4. On the **Batch** menu, click **Start** to start the download of the first file in the batch list and the STG if the option **Start STG after Batch Download** on the **Settings** menu is selected. The progress of the pulse protocol is displayed in the **Status** column of the **Batch Status Display**.
5. Click **Stop** on the **Batch** menu to stop the batch if necessary.
6. Close the **Batch Status Display** with the **Close** command.



**Warning:** The STG starts immediately after the download if the option **Start STG after Batch Download** on the **Settings** menu has been selected. Make sure to deselect this option if you do not want to start the stimulation right away.

### Autorepeat option

If you select the **Autorepeat Batch Mode** option on the **Settings** menu, the batch is restarted with the first file after the last file in the batch has been finished.

# 11 Analog Output Signals

## 11.1 Output Modes

The stimulus generator operates in voltage and current mode. Choose voltage or current mode in the main window of MC\_Stimulus II. Please make sure that you use the appropriate stimulation mode for your experiment. The difference between current and voltage controlled stimulation is described in the following.

In **voltage mode**, the **voltage** level is held constant and the current output depends on the electrode resistance. The **higher** the electrode resistance, the **lower** is the output current.

In **current mode**, the stimulus generator guarantees a stable **current** output independent of the electrode resistance, where the voltage is defined by Ohm's law. The **higher** the electrode resistance, the **higher** is the output voltage. Therefore, the **kinetic properties** of the stimulus output is affected by the load resistance, which is usually the **electrode resistance**. If the resistance is too high, the output current is **limited** by the **compliance voltage**, that is, too high resistances will result in a **clipping** of the output signal.

Please consider the **time** and **voltage / current resolution** of the stimulus generator. The minimum pulse has an amplitude of **1 mV** in voltage mode or **200 nA** in current mode supported by MC\_Stimulus II; the firmware / DLL supports a 14 bit resolution, which means 200 nA for an output current range of 0.8 mA, and a time length of **20  $\mu$ s**. Please note that if you work near these limits, that is, if you use very small amplitudes or very short pulses, the output waveform may not exactly match the programmed waveform.

### Resolution Limits

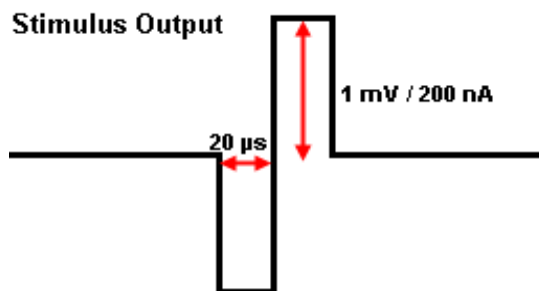

### Ground

All stimulation channels of the STG are optically isolated from each other. Each channel has an **independent** ground (**GND**), which is usually connected to the ground of the experimental setup, for example, the amplifier, so that all devices refer to the same ground. Please make sure that you always use the appropriate ground for the channel in use.

## 11.2 Voltage Mode

- If you want to operate the STG in voltage mode, you have to select "Voltage" in Output Mode of the main window of MC\_Stimulus II. You will usually use the **+** and **GND** outputs. The output signal is identical with the programmed signal in the normal ranges of the electronics' accuracy. See illustration "Voltage mode: Standard Setup".
- The output signals are **inverted** (multiplied by -1) if you use the - outputs.
- If you use the voltage between **+** and **-**, the output signal amplitude is **doubled**. The - represents the ground (replaces GND) in this case. See illustration "Voltage mode: Doubled output signal amplitude".
- A **bipolar stimulation** is recommended for extracellular recordings from microelectrode arrays (MEAs) if a very high output signal density in a defined area between two neighboring stimulating electrodes is needed. The current that is delivered by the first electrode flows directly back to the second electrode so that the surrounding tissue is not affected. See illustration "Voltage mode: Bipolar stimulation".
- In the **following example**, you see a signal in the MC\_Stimulus II display and the resulting output signals for the different connection options (viewed in a MC\_Rack **Data Display**).

Programmed stimulus protocol viewed in MC\_Stimulus

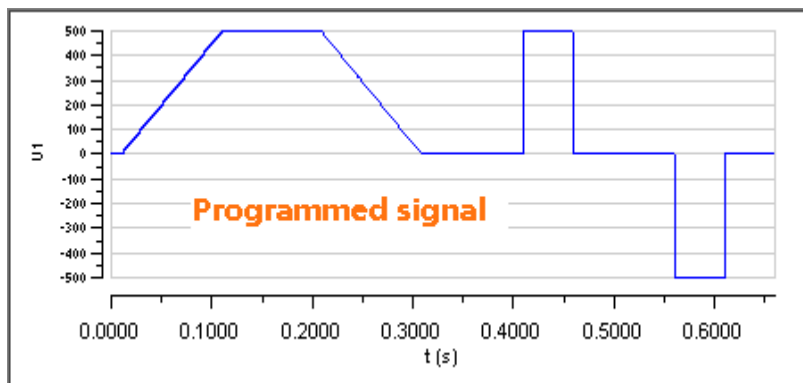

STG output signals: +U to GND

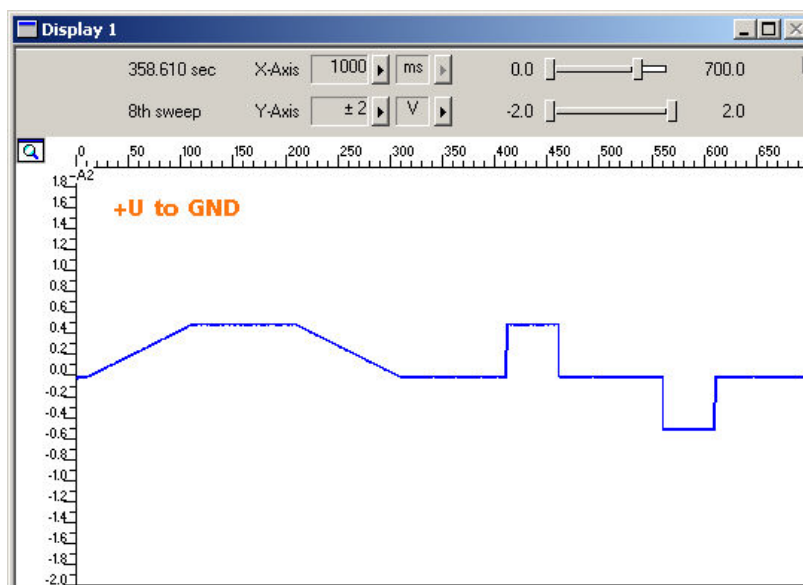

STG output signals: -U to GND

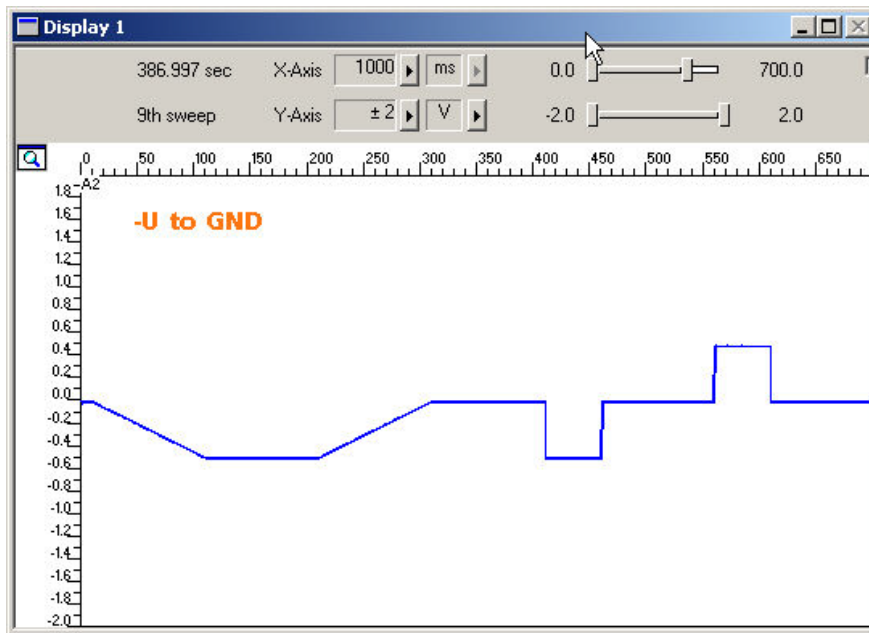

STG output signals: +U to -U

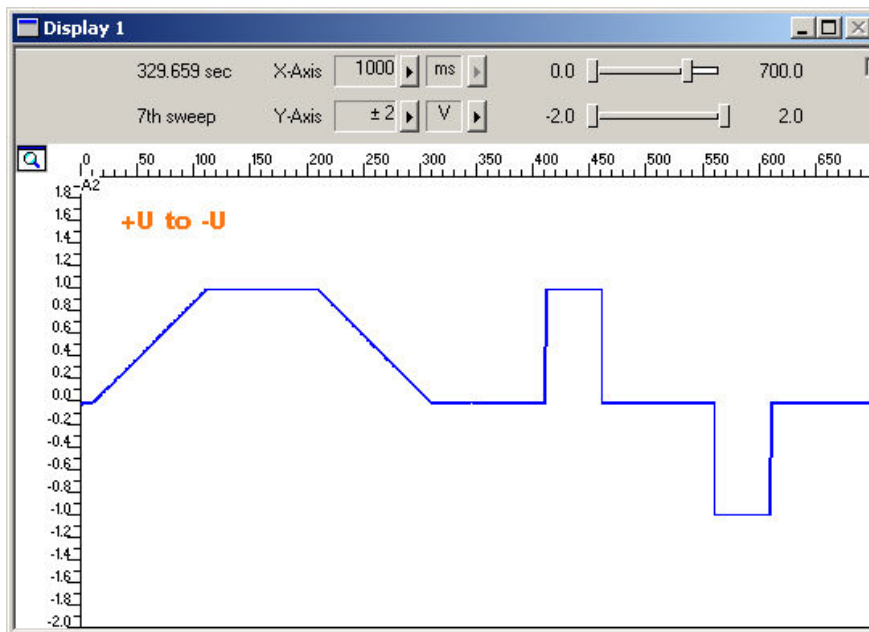

Screen shot from a standard oscilloscope triggered on the Sync Out pulse (Please see "Measuring output signals with an oscilloscope"). Green trace = voltage output (+U), red trace = inverted voltage output (-U), pink trace = TTL output from the Sync Out.

Voltage output 1 V and Sync Out.

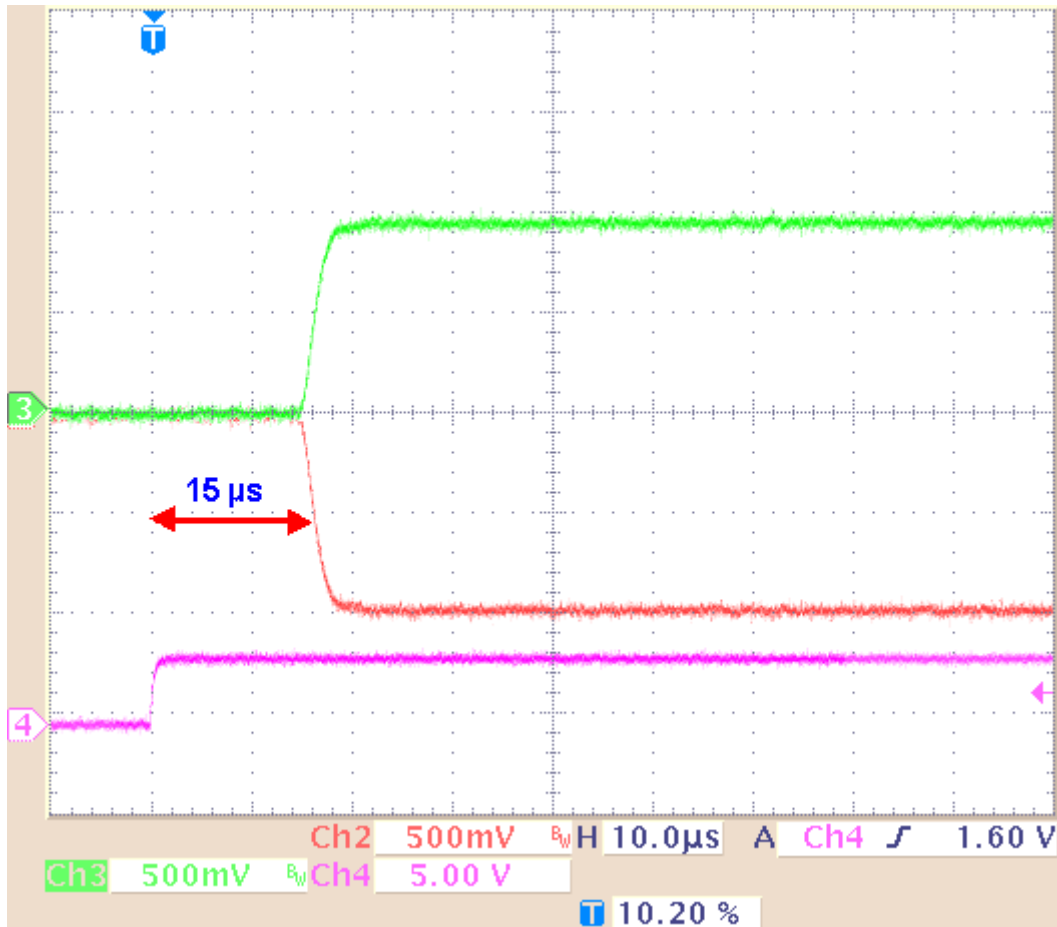

The **time lag** between the **Sync Out output**, the trigger, and the **voltage output** is approximately **15 µs (±2 µs)**

### Setup suggestions for voltage mode

The following illustrations show circuit diagrams of suggested setups. Please note that you can use **unshielded twisted pair cables** (wires twisted round each other) instead of a shielding to prevent the amplifier from picking up noise. The experimental ground can be, for example, the amplifier's ground or a Faraday cage.

If you use the stimulus generator together with a standard MEA amplifier, you can also use the **provided 3-polar cable** for directly connecting the stimulus generator to the electrode inputs of the MEA amplifier. Please note that a shielded cable is generally not necessary if you use a MEA1060 amplifier with blanking circuit. For more details on the recommended setup for this amplifier type, please refer to the "MEA1060 Amplifier with Blanking Circuit" manual.

### Voltage mode: Standard setup

Stimulus generator outputs

MEA amplifier inputs

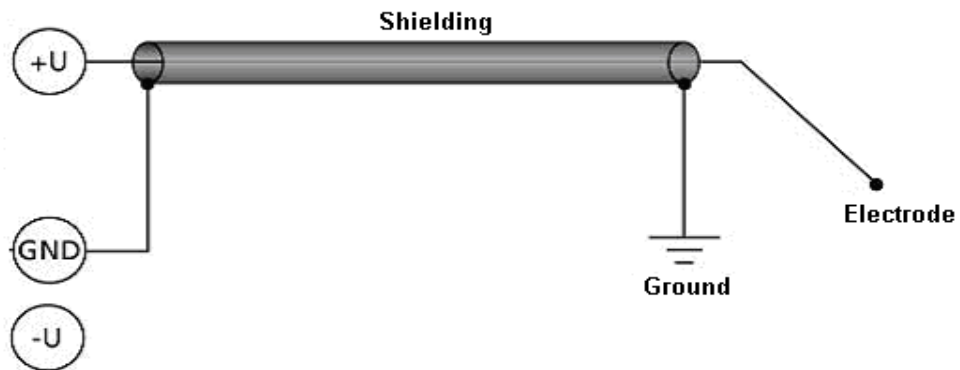

### Voltage mode: Doubled output signal amplitude

Stimulus generator outputs

MEA amplifier inputs

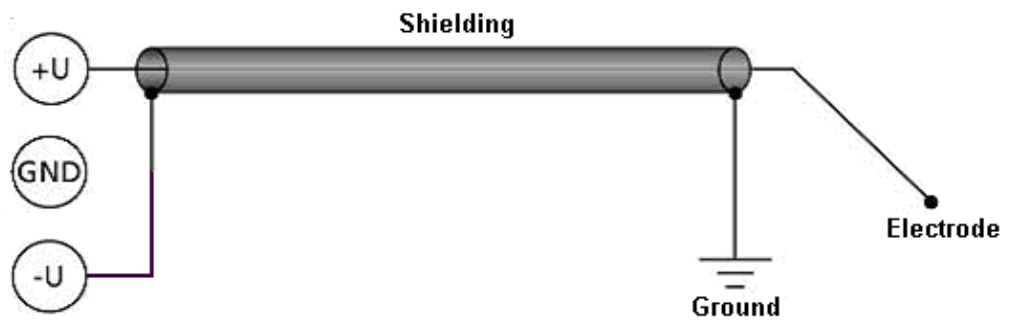

### Voltage mode: Dipolar stimulation

Stimulus generator outputs

MEA amplifier inputs

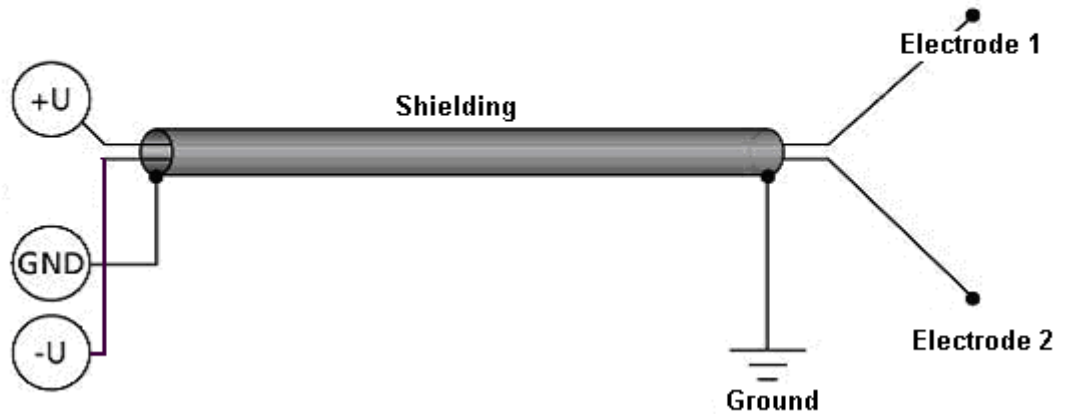

## 11.3 Current Mode

If you want to operate the STG in current mode, you have to select "Current" in Output Mode of the main window of MC\_Stimulus II. You will usually use the **+** and **GND** outputs. See illustration "Standard setup".

**Note:** In current mode, a protection switch disconnects the current source from the electrode, to avoid leak currents. The switch opens as soon as the stimulation pattern starts. To allow some time for the switch to open, it is recommended to start current pulses with a short period of 0  $\mu$ A. 40  $\mu$ s is sufficient.

The output signals are **inverted** (multiplied by -1) if you use the - outputs.

If the **load resistance**, that is, the **electrode impedance** is very high, the **output voltage** can get very high, too. The stimulus generator **limits** the output voltage to **75 V** between + or - and GND. The guaranteed compliance voltage is  **$\pm 60$  V**, that means 120 V between + and -.

The **current output** of the STG is **limited** by the **compliance voltage** and the **electrode impedance**. If the maximum load resistance for a given current output is exceeded, the compliance voltage (60 V between +I and GND) of the STG will not be sufficient for delivering enough current, and the output will be **clipped**. You can calculate the maximum load resistance by Ohm's law. For example, if you want to program a 100  $\mu$ A pulse, the maximum load resistance will be 600 k $\Omega$ . According to Ohm's law:  $R = U / I = 60 \text{ V} / 100 \mu\text{A} = 600 \text{ k}\Omega$ , that is, 60 V are sufficient for delivering a current of 100  $\mu$ A at a load resistance of 600 k $\Omega$ . Therefore, if you use current driven stimulation, you should always take the impedance of the stimulating electrodes into account when planning your stimulus protocol. You should also keep in mind that most electrodes or amplifiers support only limited voltages.

You can **increase** the compliance voltage to **120 V** by using the **+** and **-** outputs. The output current even at the maximum output voltage of 150 V should not be dangerous to human health because the maximum output current in current mode is only  **$\pm 1.6$  mA**. See illustration "Doubled maximal output voltage".

A **bipolar** stimulation is recommended for extracellular recordings from microelectrode arrays (MEAs) if a very high output signal density in a defined area between two stimulating electrodes is needed. The current that is delivered by the first electrode flows directly back to the second electrode so that the surrounding tissue is not affected. See illustration "Dipolar stimulation".

Screen shot from a standard oscilloscope triggered on the Sync Out pulse (Please see "Measuring output signals with an oscilloscope"). Green trace = current output (+I), red trace = inverted current output (I), pink trace = TTL output from the Sync Out.

Current output 200  $\mu$ A and Sync Out.

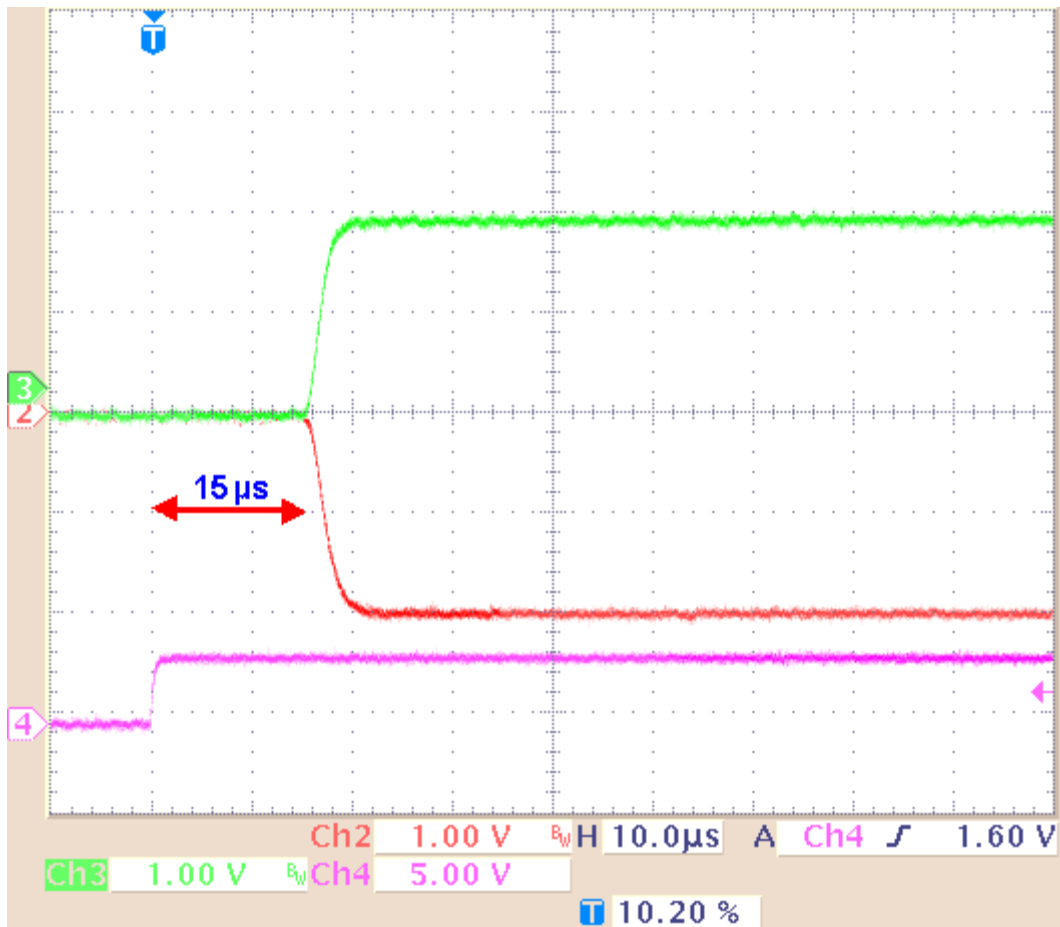

The **time lag** between the **Sync Out output** and the **current output** is approximately **15  $\mu$ s (+/- 2  $\mu$ s)** if continuous mode is enabled and **50  $\mu$ s (+/- 2  $\mu$ s)** if continuous mode is disabled.

### Setup suggestions for current mode

The following illustrations show circuit diagrams of suggested setups. Please note that for current stimulation, you should use shielded cables to protect your setup against electromagnetic interference. The experimental ground can be, for example, the amplifier's ground or a Faraday cage.



**Current mode: Standard setup**

Stimulus generator outputs

MEA amplifier inputs

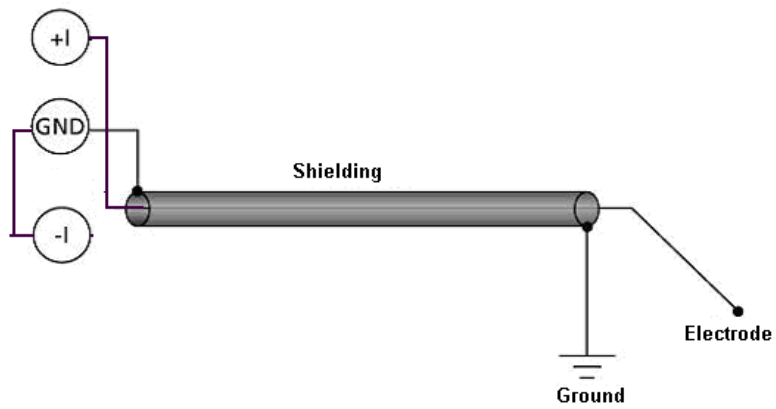

**Current mode: Double maximal compliance voltage**

Stimulus generator outputs

MEA amplifier inputs

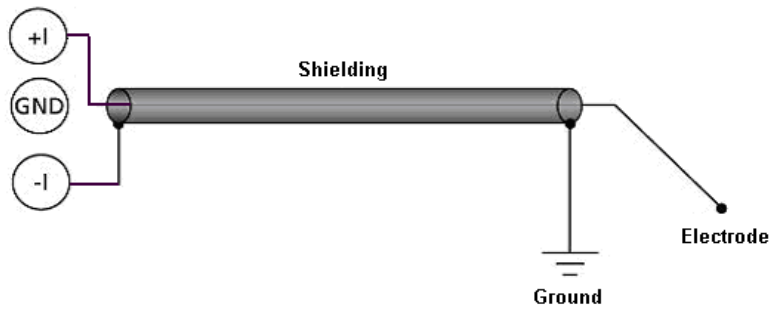

**Current mode: Dipolar stimulation**

Stimulus generator outputs

MEA amplifier inputs

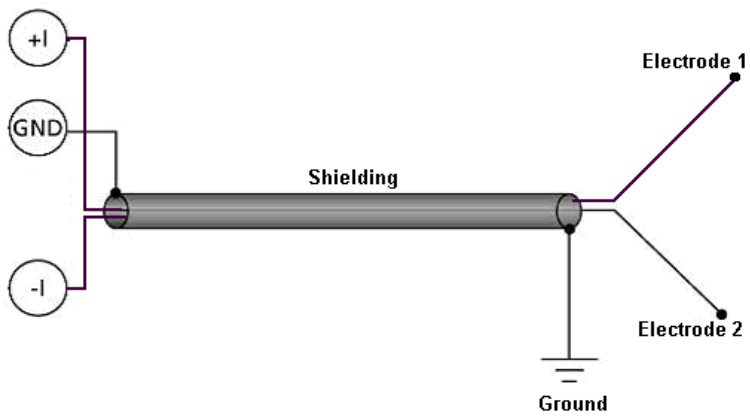

## 11.4 Measuring Output Signals with an Oscilloscope

For test purposes, you can measure the output signals with an oscilloscope. Please see the appendix for the pin layout of the sockets on the front panel of the STG 4000 series.

Most standard oscilloscopes have a probe with a ground cable. This probe is usually connected to the oscilloscope via a BNC socket. What you do for measuring the **voltage output** is the following: Choose voltage mode in the main menu of the MC\_Stimulus II software. You plug in the standard STG cables into the +U output and the corresponding GND output. You then touch the open end of the cable from the +U output with the probe from the oscilloscope, and the open end of the cable from the GND output with the ground cable from the probe. This means you measure the **potential difference** between the **+U output** and **ground**.

Please note that you need a resistor in parallel to measure the **current output** properly because oscilloscopes measure voltages. If the input resistance of the oscilloscope is too low, the voltage output of the STG will be small as well, and you will not see any signals on the oscilloscope. MCS recommends a resistor of **10 kΩ** because the output signal of the current output should then be identical to the output signal of the voltage output. You can use the same test protocol regardless of the output mode for the current and voltage outputs, and compare the signals. As an alternative, you can also use a resistor that mimics the electrode resistance for testing your experiments.

Choose current mode in the main menu of the MC\_Stimulus II software. What you do is, you plug in cables into the **+I output** and into the **GND** output of the STG. You then use alligator crimps for connecting a **10 kΩ resistor** between the two open ends of the cables. You then touch the cable on one side of the resistor with the probe and on the other side with the ground of the probe. Alternatively use the provided cable with integrated 10 kΩ resistor. That is, you measure the **potential difference** over the **resistor**. You can then calculate the current output according to Ohm's law ( $U = R \cdot I$ ). For example, if you stimulate with 100 μA, the voltage over the 10 kΩ resistor has to be  $U = 10000 \Omega \cdot 0.1 \text{ mA} = 1000 \text{ mV} = 1 \text{ V}$ .

The following illustration shows four possible combinations of connecting the current outputs on the front panel of the stimulus generator to the oscilloscope. Again, it is important that unused current outputs are connected to ground.

### Measuring current output signals with an oscilloscope

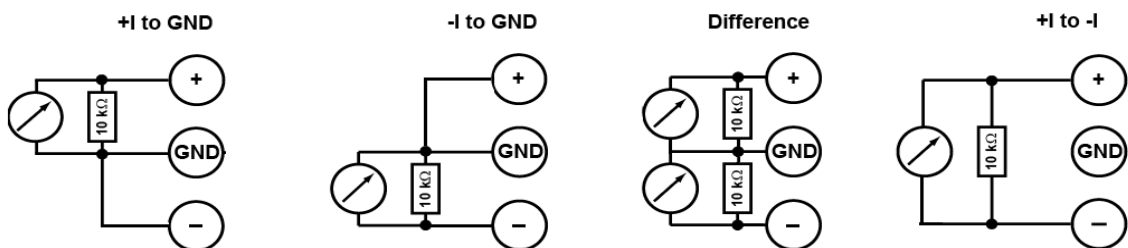

## 11.5 Rise Time

The **rise time** of the **voltage output** is constant and independent from the stimulus protocol. The **rise time** of the **current output** is no fixed hardware property. The kinetics depend on the **amplitude** of the current pulse and the **load resistance**, that is, generally the electrode impedance. The resistance affects the kinetics much stronger than the amplitude.

Generally, this does not make much difference for biological applications. If you have **very time-critical applications**, or if you use **very short pulses**, you should **check the output** of the STG **with an oscilloscope** before starting the experiment.

### Amplitude dependency of rise time

The **rise time** is independent from the current amplitude in the common range of amplitudes. The rise time (10 % / 90 %) was measured with increasing current amplitudes (100  $\mu\text{A}$  to 1600  $\mu\text{A}$ ) and a constant load resistance of 10  $\text{k}\Omega$ . The **output current** is nearly constant up to amplitudes of 1100  $\mu\text{A}$ , but increases about 0.3  $\mu\text{s}$  until the maximum of 1600  $\mu\text{A}$  amplitude is reached. The relationship is not linear as shown by the following curve.

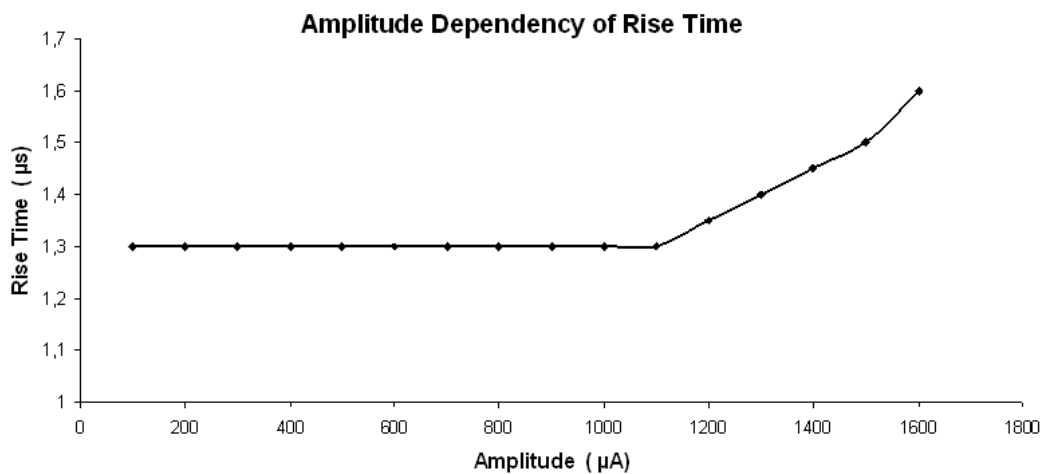

### Resistance dependency of rise time

The **higher** the **load resistance**, the **higher** will be the **rise time**. The rise time (10 % / 90 %) was measured with increasing load resistances and a constant current amplitude of 50  $\mu\text{A}$ . For 50  $\mu\text{A}$  pulses, the relationship is linear up to the maximum load resistance (Please see "Current Mode") as shown by the following curve. Not shown are the results of the same measurement under the same conditions, except of the amplitude with a constant current amplitude of 100  $\mu\text{A}$ . Up to a load resistance of 450  $\text{k}\Omega$ , the results are congruent with 50  $\mu\text{A}$  amplitude.

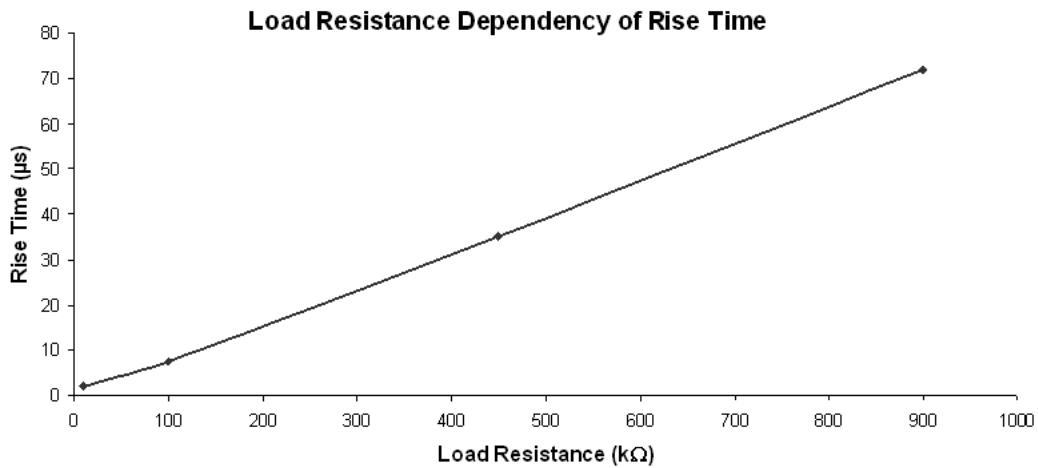

### Stimulus output comparison

The following figures are examples for demonstrating how the **amplitude** and **resistance** will affect the **kinetics** of a **current pulse**. These images document also that in contrast to the current mode, in **voltage mode**, the **rise time** is **constant** and not dependent on the amplitude or load resistance.

The graphs were generated by a standard oscilloscope. The devices were set up according to the recommendations under "Voltage Mode" and "Current Mode". The same pulse protocol and the same channel number of the STG outputs were used for measuring the voltage and the current output.

**Example 1a:** Voltage Mode: The **green** trace shows the voltage (+U) output; and the **pink** trace shows the TTL output from the **Sync Out** that was used for triggering the oscilloscope.

Rise time with programmed 500 mV and 50  $\mu$ A pulses, 10 k $\Omega$  load resistance.  
Rise time (10 % / 90 %) = 3  $\mu$ s.

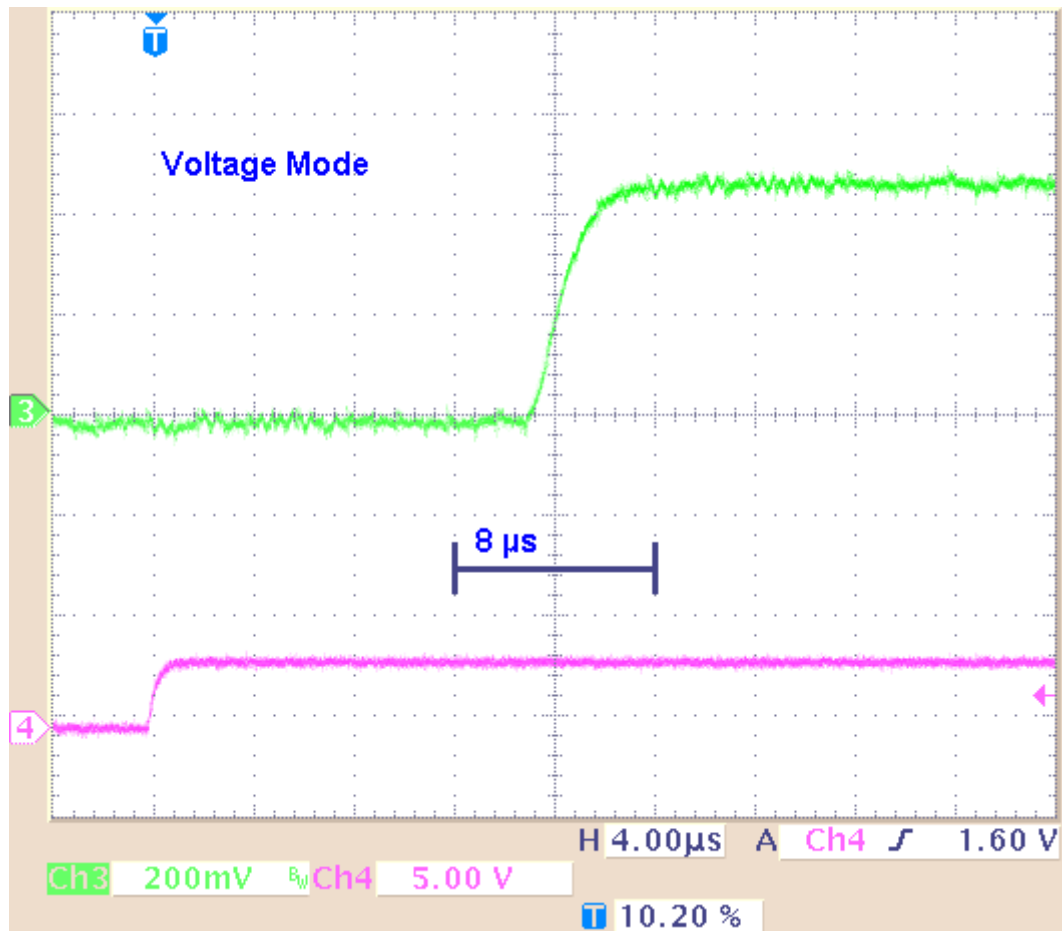

**Example 1b:** Current Mode: The **green** trace shows the current output (+I) with a load resistance of **10 k $\Omega$** ; and the **pink** trace shows the TTL output from the **Sync Out** that was used for triggering the oscilloscope.

Rise time with programmed 500 mV and 50  $\mu$ A pulses, 10 k $\Omega$  load resistance.

Rise time (10 % / 90 %) = 3  $\mu$ s.

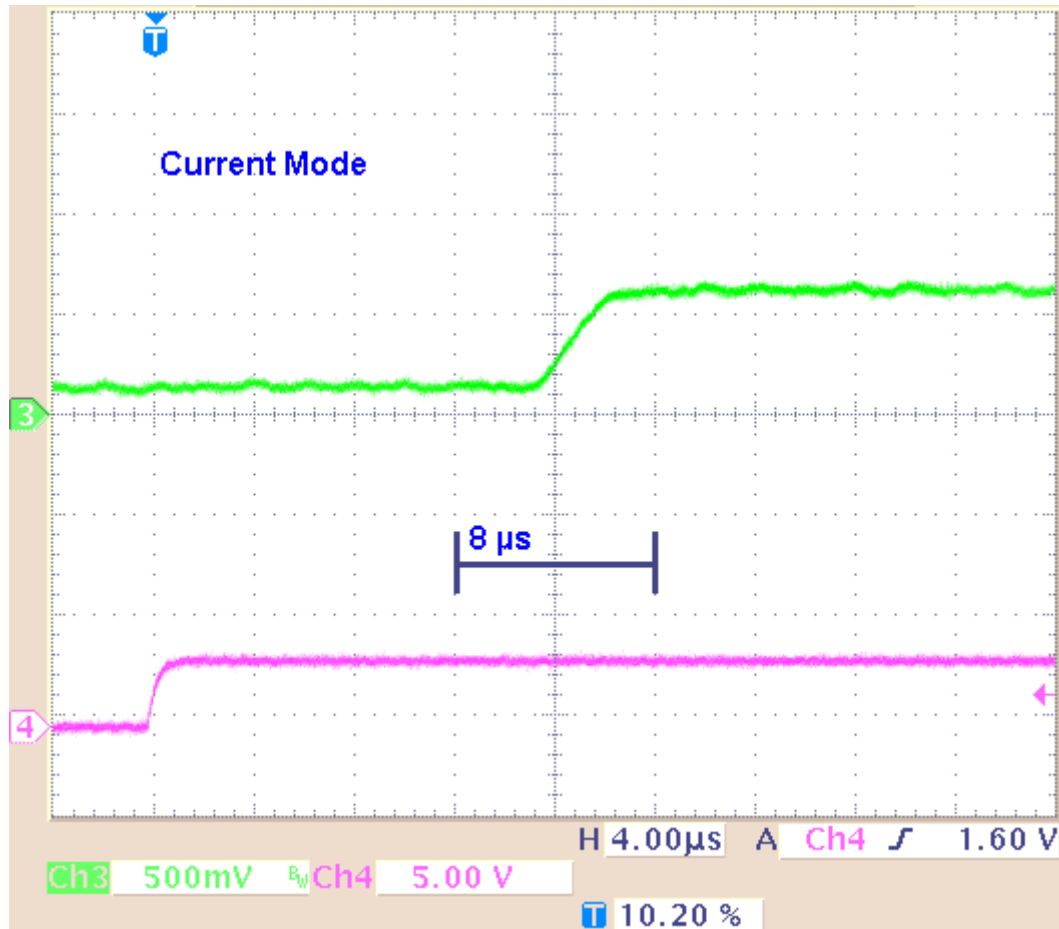

**Result of Example 1:** The rise time is about 3  $\mu$ s for the 500 mV voltage pulse, and about 3  $\mu$ s for the 50  $\mu$ A current pulse.

**Example 2a:** Voltage Mode: The **green** trace shows the voltage (+U) output; and the **pink** trace shows the TTL output from the **Sync Out** that was used for triggering the oscilloscope.

Rise time with programmed 5 V and 500  $\mu$ A pulses, 10 k $\Omega$  load resistance.  
Rise time (10 % / 90 %) = 3  $\mu$ s.

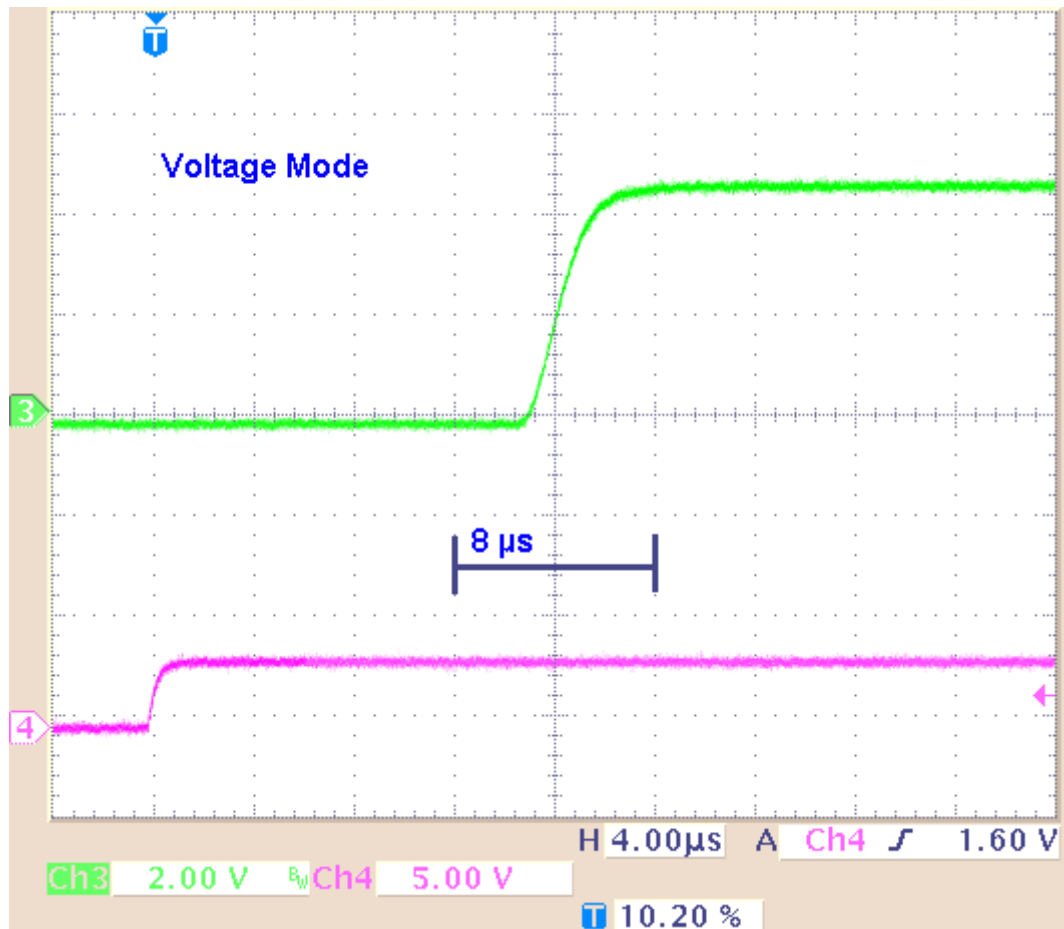

**Example 2b:** Current Mode: The **green** trace shows the current output (+I) with a load resistance of **10 k $\Omega$** ; and the **pink** trace shows the TTL output from the **Sync Out** that was used for triggering the oscilloscope.

Rise time with programmed 5 V and 500  $\mu$ A pulses, 10 k $\Omega$  load resistance.

Rise time (10 % / 90 %) = 3  $\mu$ s.

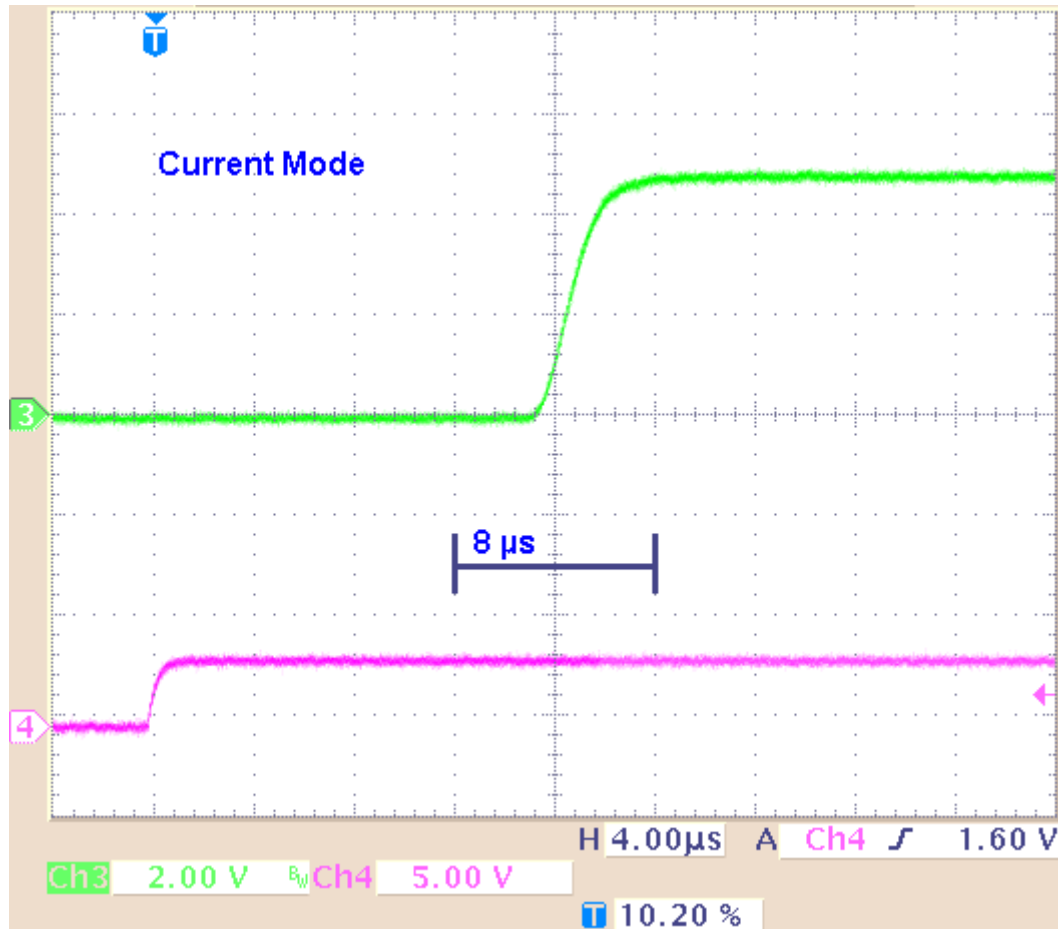

**Result of Example 2:** The kinetics and the rise time of the 5 V voltage pulse are comparable to the 500 mV pulse. The approximate 3  $\mu$ s rise time of the 500  $\mu$ A current pulse is not higher than the rise time of the 50  $\mu$ A pulse.



**Example 3a:** Current Mode: The **red** trace shows the current output (**+I**) with a load resistance of **100 k $\Omega$** ; and the **pink** trace shows the TTL output from the **Sync Out** that was used for triggering the oscilloscope.

Rise time with programmed 5 V and 500  $\mu$ A pulses, 100 k $\Omega$  load resistance.  
Rise time (10 % / 90 %) = 12  $\mu$ s.

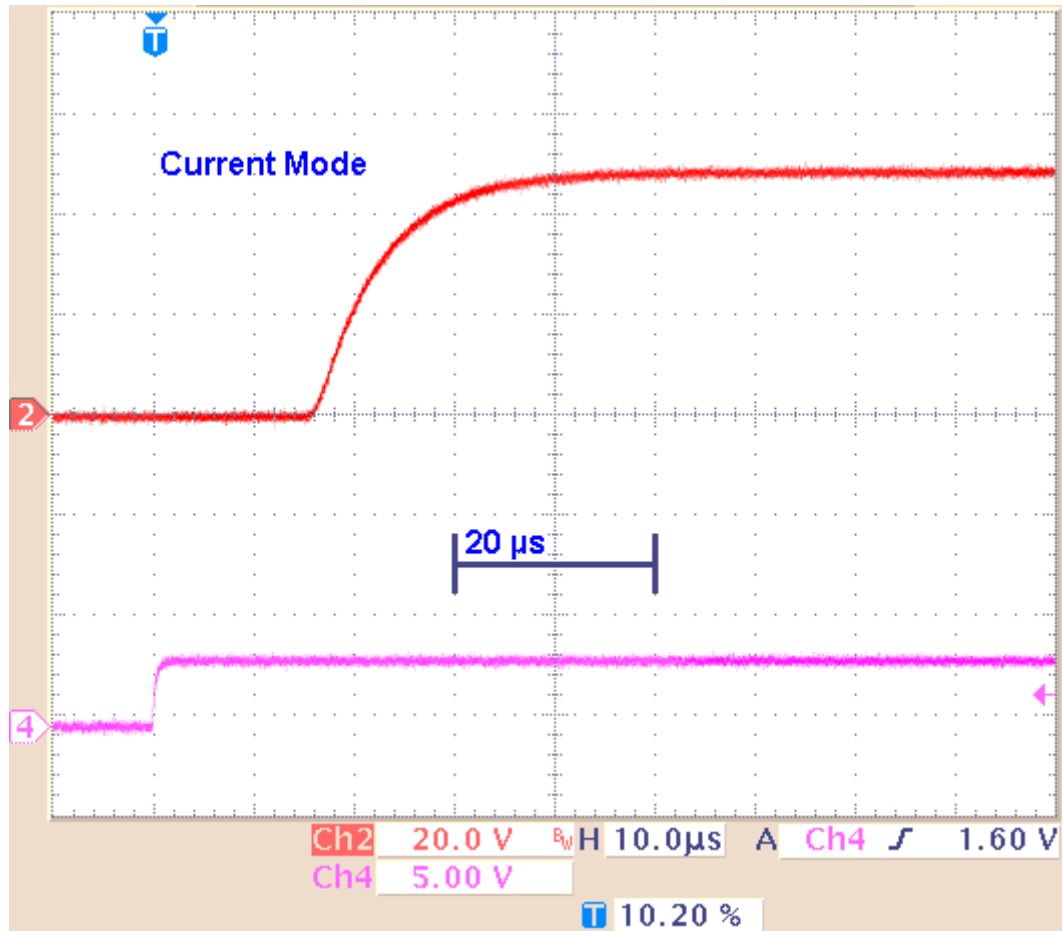

**Example 3b:** Current Mode: The **green** trace shows the current output (+I) with a load resistance of **1 M $\Omega$** ; and the **pink** trace shows the TTL output from the **Sync Out** that was used for triggering the oscilloscope.

Rise time with programmed 5 V and 500  $\mu$ A pulses, 1 M $\Omega$  load resistance.  
Rise time (10 % / 90 %) = 120  $\mu$ s.

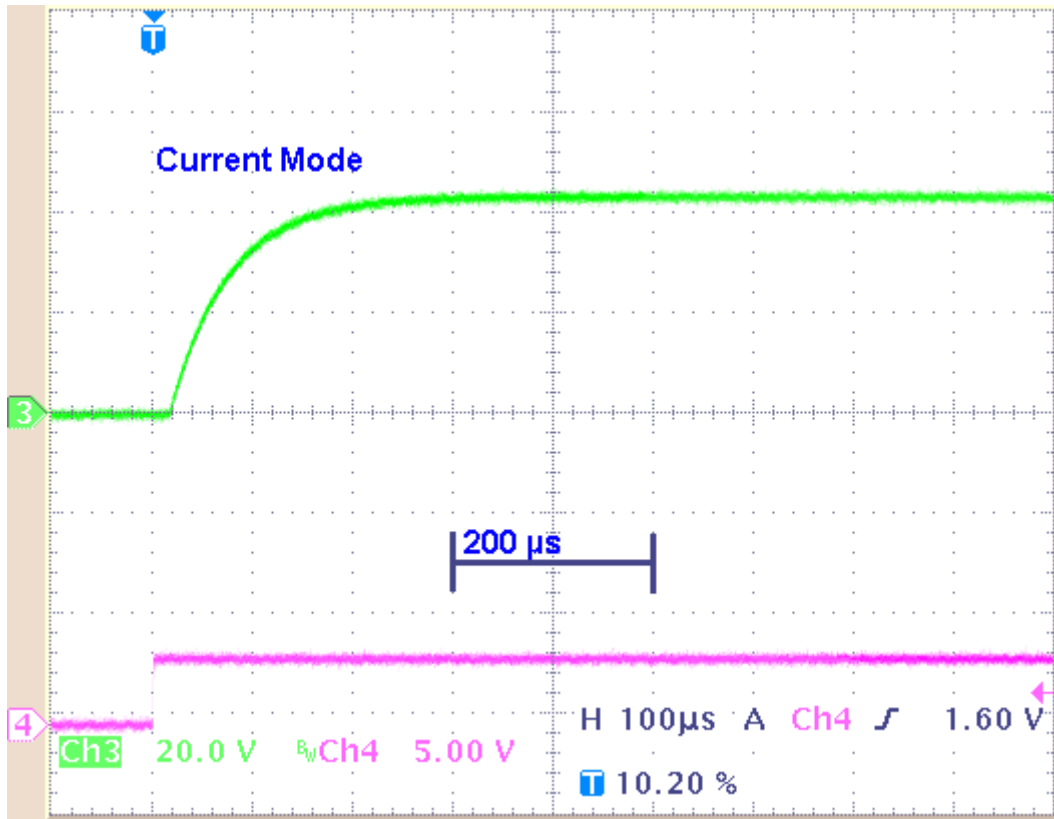

**Result of Example 3:** With a higher load resistance, the current pulse shows a different kinetic behavior: The rise time increases significantly (about 100  $\mu$ s). Please keep in mind that the resistance of the oscilloscope probe with 10 M $\Omega$  is parallel to the 1 M $\Omega$  load resistance. That means, that the maximum of the load resistance is reduced to 900 k $\Omega$  only.

## 11.6 Comparison of Output Signals in Current Mode

To show the different behavior of the output signals in current mode, there are some examples to get an idea how the stimulus generator will deliver the stimulus pulses. The screen shots are from a standard oscilloscope triggered on the Sync Out pulse (see "Measuring output signals with an oscilloscope").

**Example 1:** Influence of the length of a current pulse 100  $\mu\text{s}$  versus 20  $\mu\text{s}$  with an amplitude of 1600  $\mu\text{A}$ , which is at the maximum capacity of the STG 4002 (constant amplitude and load resistance).

**Example 1a:** Current pulse with programmed 1600  $\mu\text{A}$  for 100  $\mu\text{s}$  and 20  $\mu\text{s}$  interval and 10  $\text{k}\Omega$  load resistance.

The pulse is biphasic, and 1600  $\mu\text{A}$  which is the limit of the maximum capacity of the STG 4002. Green trace = current output (+), pink trace = TTL trigger output from the Sync Out.

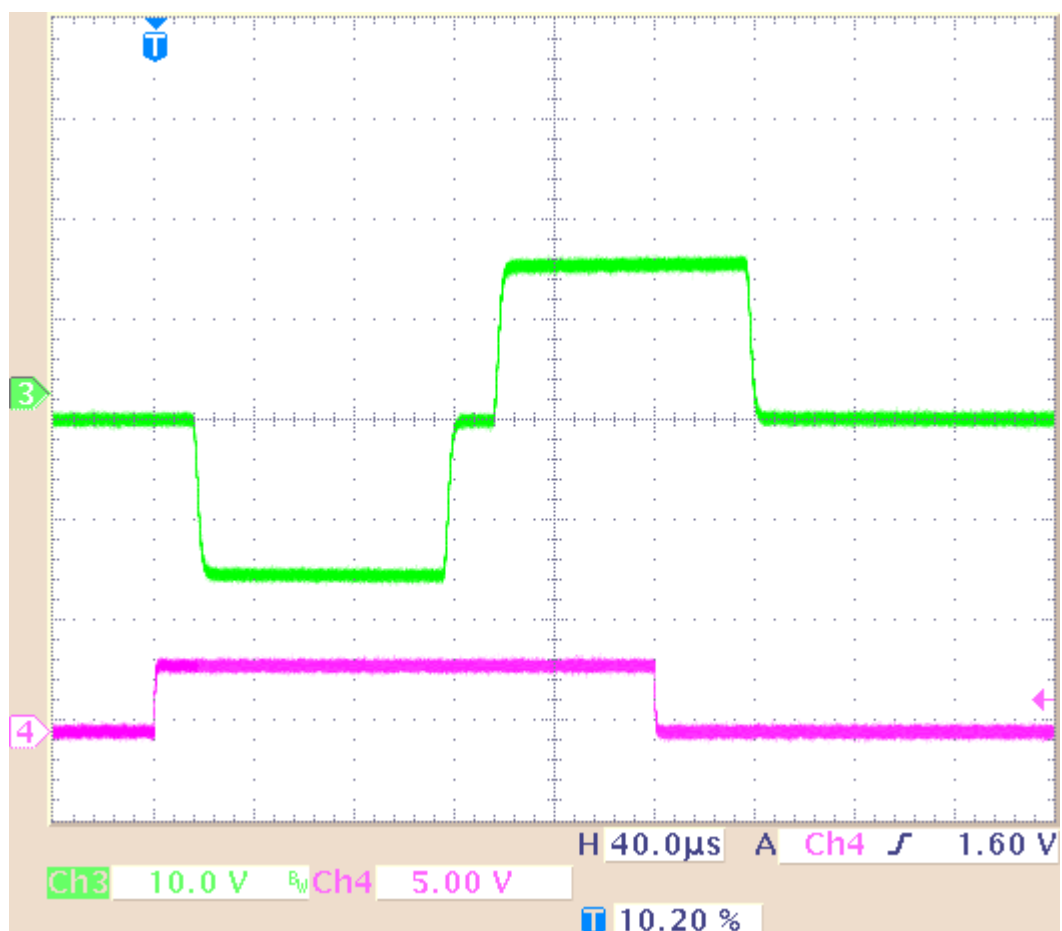

**Example 1b:** Current pulse with programmed 1600  $\mu\text{A}$  for 20  $\mu\text{s}$  and 20  $\mu\text{s}$  interval and 10  $\text{k}\Omega$  load resistance.

The pulse is biphasic, and 1600  $\mu\text{A}$  which is the limit of the maximum capacity of the STG 4002. Green trace = current output (+), pink trace = TTL trigger output from the Sync Out.



**Result of Example 1:** The current output signal is delivered unmodified without any influence of the length of the pulse with an amplitude of 1600  $\mu\text{A}$  which is at the maximum capacity of the STG 4002.

**Example 2:** Influence of the length of a current pulse 100  $\mu\text{s}$  versus 20  $\mu\text{s}$  with an amplitude of 16  $\mu\text{A}$  which is a hundredth of the limit of the maximum capacity of the STG 4002 (constant amplitude and load resistance).

**Example 2a:** Current pulse with programmed 16  $\mu\text{A}$  for 100  $\mu\text{s}$  and 20  $\mu\text{s}$  interval and 10  $\text{k}\Omega$  load resistance.

The pulse is biphasic, 16  $\mu\text{A}$  Green trace = current output (+I), pink trace = TTL trigger output from the Sync Out.

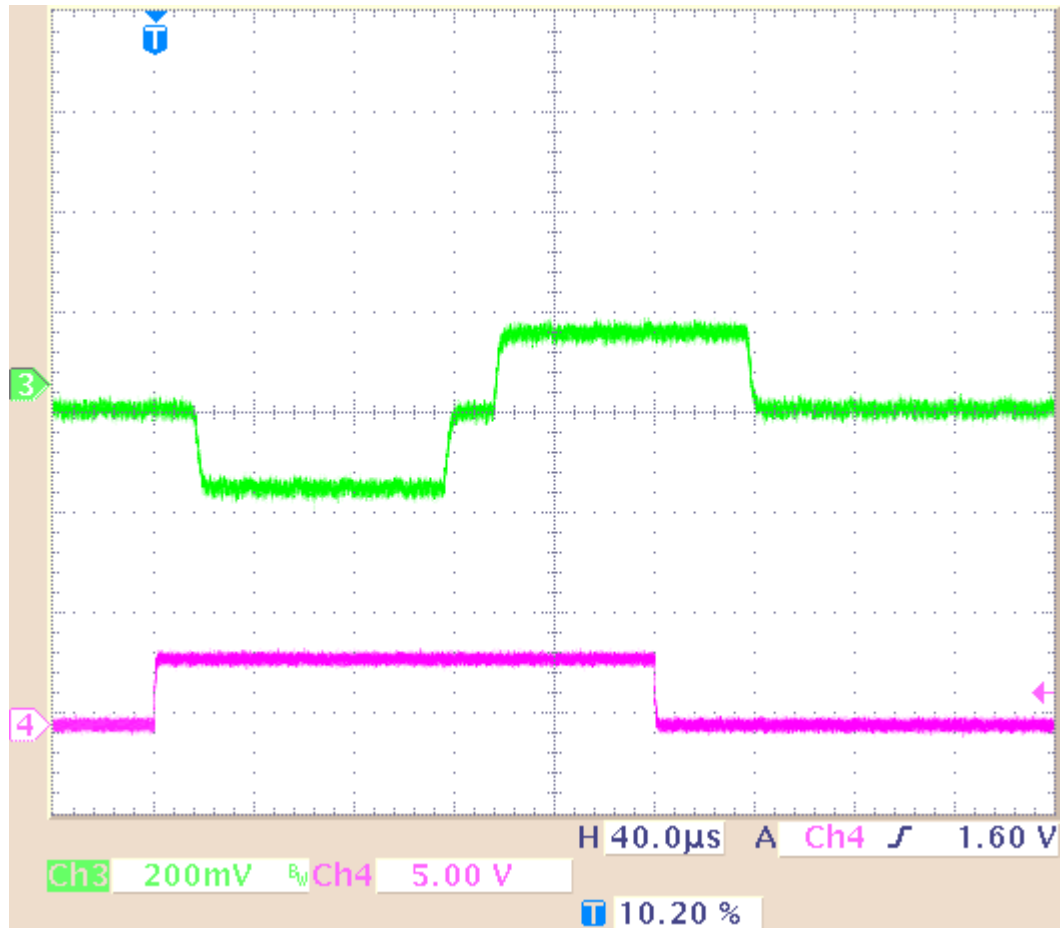

**Example 2b:** Current pulse with programmed 16  $\mu\text{A}$  for 20  $\mu\text{s}$  and 20  $\mu\text{s}$  interval and 10  $\text{k}\Omega$  load resistance.

The pulse is biphasic, 16  $\mu\text{A}$ . Green trace = current output (+I), pink trace = TTL trigger output from the Sync Out.

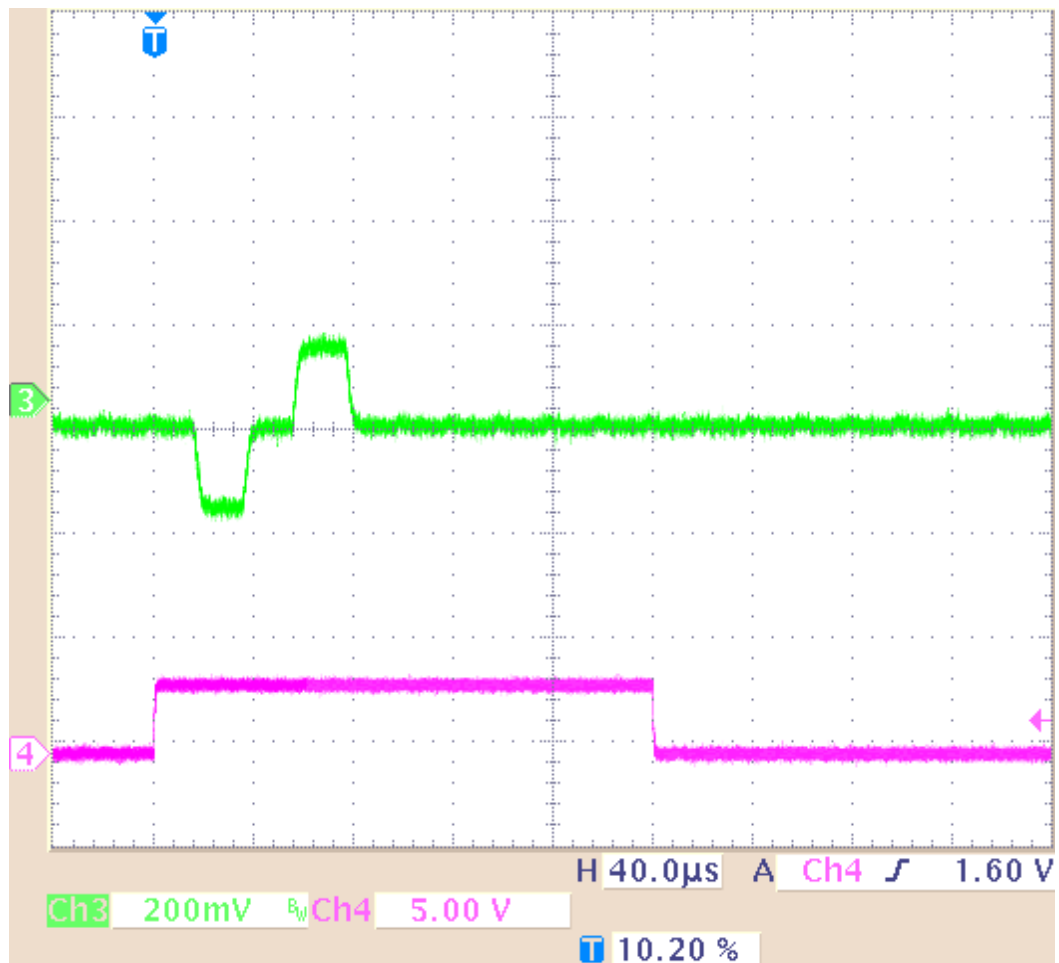

**Result of Example 2:** The current output signal is delivered unmodified without any influence of the length of the pulse, and an amplitude of 16  $\mu\text{A}$  which is a hundredth of the limit of the maximum capacity of the STG 4002

**Example 3:** Influence of the length of a current pulse and a high load resistance. Current pulse with programmed 16  $\mu\text{A}$  for 100  $\mu\text{s}$  and 20  $\mu\text{s}$  interval and 1  $\text{M}\Omega$  load resistance. The load resistance is very high. Please keep in mind that the load resistance of 1  $\text{M}\Omega$  is parallel to 10  $\text{M}\Omega$  of the probe of the oscilloscope. That means, the load resistance is reduced to 900  $\text{k}\Omega$  only.

The pulse is biphasic, and 16  $\mu\text{A}$  which is a hundredth of the limit of the maximum capacity of the STG 4002. Green trace = current output (+), pink trace = TTL trigger output from the Sync Out.

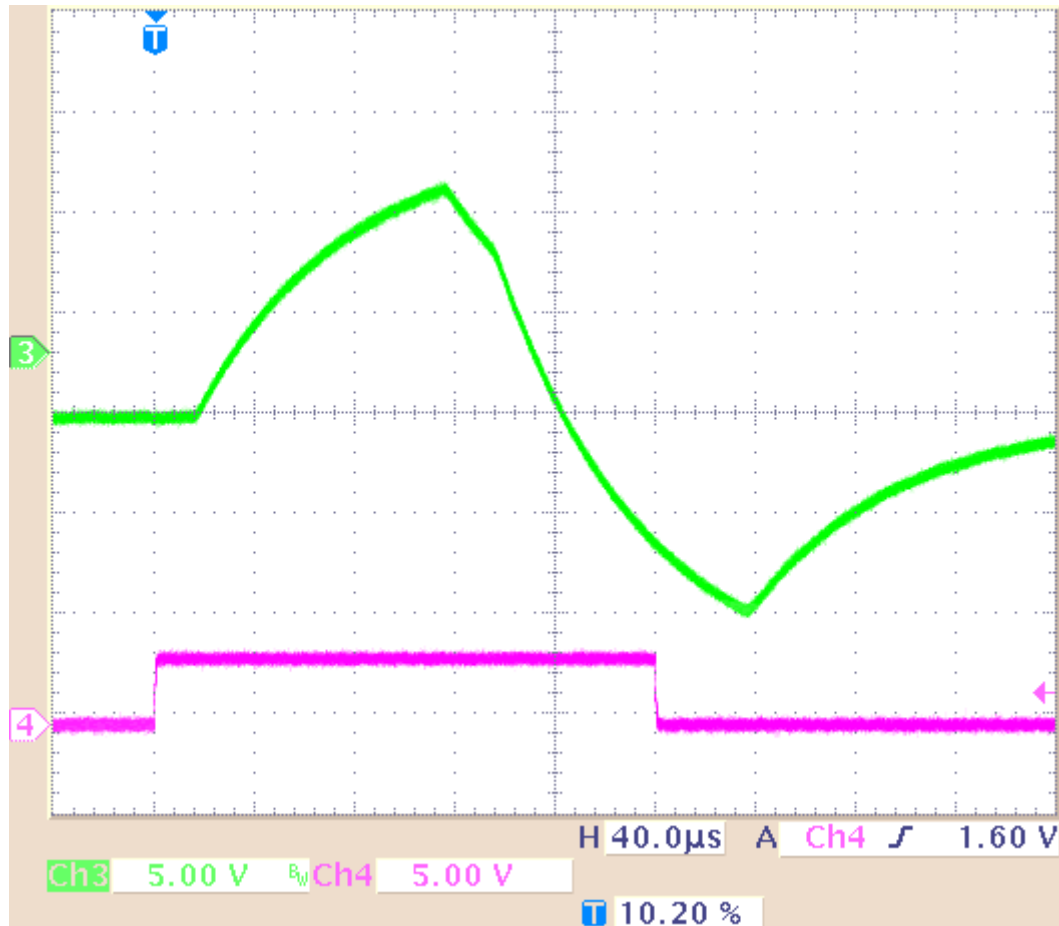

**Result of Example 3:** The current output signal is delivered strongly modified because of the high load resistance of 1  $\text{M}\Omega$ , and the duration of the pulse, 100  $\mu\text{s}$  and the interval. Before the pulse is reaching its maximum, it has to turn into its invert phase. Before the pulse is reaching its minimum, it is cut off. Please see example 4: If the duration of pulse and interval is much longer, 1 ms, the pulse shape of the delivered signal is much better.

**Example 4:** Influence of the length of a current pulse and a high load resistance. Current pulse with programmed 50  $\mu\text{A}$  for 1 ms and 1 ms interval and 1  $\text{M}\Omega$  load resistance. The load resistance is very high, the duration of the pulse and the interval are long. Please keep in mind that the load resistance of 1  $\text{M}\Omega$  is parallel to 10  $\text{M}\Omega$  of the probe of the oscilloscope. That means, the load resistance is reduced to 900  $\text{k}\Omega$  only. The long pulse is biphasic, 50  $\mu\text{A}$ . Green trace = current output (+), pink trace = TTL trigger output from the Sync Out.



**Result of Example 4:** The current output signal is delivered negligible modified when the duration of the signal and the duration of the interval is long, for example 1 ms.



## 11.7 Capacitive Behavior of Stimulation Electrodes

Regarding the generally used stimulus pulses, stimulating electrodes behave as plate capacitors. They need some time to discharge themselves after stimulation. As a result, artifacts interfere with the recording, and electrodes deteriorate over time due to electrolysis. This effect takes place especially in **current** mode because the current cannot flow back to the stimulus generator due to the high output resistance in current mode and thus is kept in the electrode. A current source can constantly produce small currents, even though the current is set to zero. This might damage the connected electrodes over time. To avoid this problem, the STG4002 is equipped with switches that automatically disconnect the current outputs from the current source 1 s after each programmed current stimulus. For the next stimulus, the current source is automatically reconnected.

To reduce the effect described above in **current mode**, you should use **biphasic pulses** for stimulation. The stimulus signal should be immediately followed by an **inverse** signal of the **same** area (product of current and time), which helps to discharge the electrode. The easiest way is to use the same signal amplitude with an opposite polarity.

Multi Channel Systems recommends using voltage driven stimulation. In **voltage mode**, it is **not** necessary to use biphasic stimulation for discharging the electrodes, because the electrode should be discharged at a voltage of 0, that is, it would be sufficient to apply the negative phase only.



**Warning:** When using MEA electrodes of **TiN** material, stimulation with higher amplitudes is possible if you apply the **negative pulse first**. Also, regard the **safe charge-injection limit** as described in the MEA manual. Otherwise, electrodes can be damaged during stimulation.

The following illustration shows the effect of a biphasic current pulse on the discharge of the stimulation electrode. As you can see, the first monophasic pulse is followed immediately by a pulse of the opposite polarity and the same product of current and time.

### Effect of a bipolar current pulse on the electrode voltage

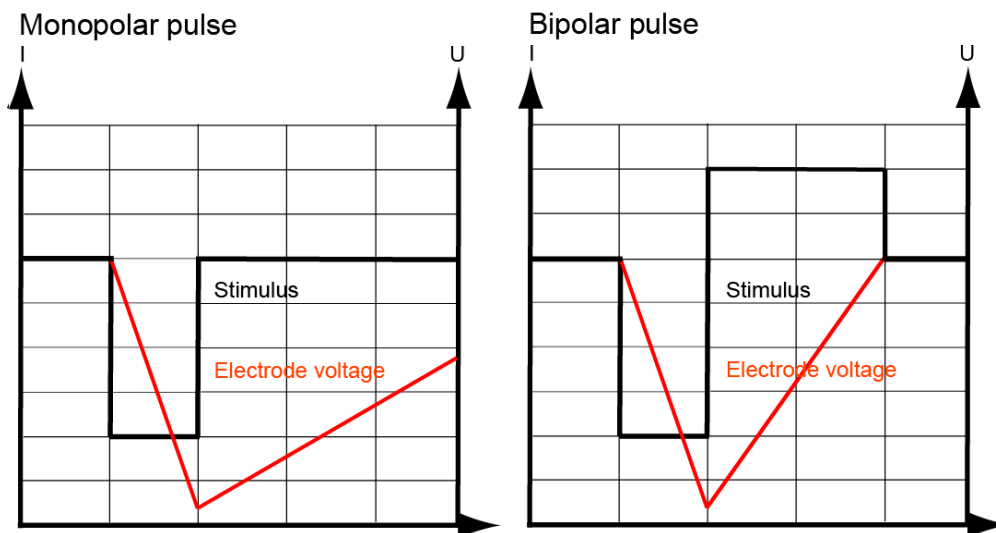



## 12 Troubleshooting

### 12.1 About Troubleshooting

Most problems occur seldom and only under specific circumstances. In most cases, it is only a minor problem that can be easily avoided or solved.

If the problem persists, please contact your local retailer. The highly qualified staff will be glad to help you. Please inform your local retailer as well, if other problems that are not mentioned in this documentation occur, even if you have solved the problem on your own. This helps other users, and it helps MCS to optimize the instrument and the documentation.

Please pay attention to the safety and service information (chapter "Important Safety Advice" in the manual or help). Multi Channel Systems MCS GmbH has put all effort into making the product fully stable and reliable, but like all high-performance products, it has to be handled with care.

### 12.2 Technical Support

Contact your local retailer immediately if the cause of trouble remains unclear. Please understand that information on your hardware and software configuration is necessary to analyze and finally solve the problem you encounter.

If you have any questions or if any problem occurs that is not mentioned in this document, please contact your local retailer. The highly qualified staff will be glad to help you.

#### Please keep information on the following at hand

- **Description** of the **error** (the error message text or any other useful information) and of the context in which the error occurred. Try to remember all steps you had performed immediately before the error occurred. The more information on the actual situation you can provide, the easier it is to track the problem.
- The **serial number** of the device. You will find it on the device or click on the **Help** menu, click **About**.
- The **software (SW) and hardware (HW) version** you are currently using. On the **Help** menu, click **About**. The displayed dialog box shows the version numbers.
- The **operating system** and service pack number on the connected **computer**.
- The **hardware configuration** (microprocessor, frequency, main memory, hard disk) of the connected **computer**. This information is especially important if you have modified the computer or installed new hard- or software recently.

## 12.3 Error Messages

This chapter explains error messages to you that may occur during normal operation. They do not present a reason to worry and can be easily avoided.

### General operation

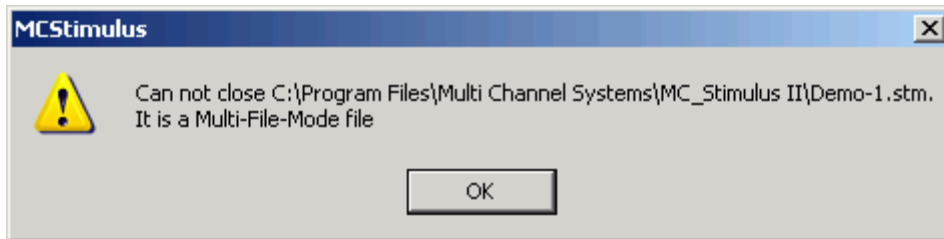

is displayed when you try to close a file in **Multi-File** mode. You cannot close files if you are in **Multi-File** mode (indicated on the MC\_Stimulus status bar). Please leave the **Multi-File** mode by selecting **Standard** under **Mode** in the **Trigger Settings** dialog box before closing files.

### Download

These error messages may occur during download on the STG. Please note that you can switch off some of these messages if they disturb your experiment. See chapter "Downloading Stimuli" for more details on downloading.

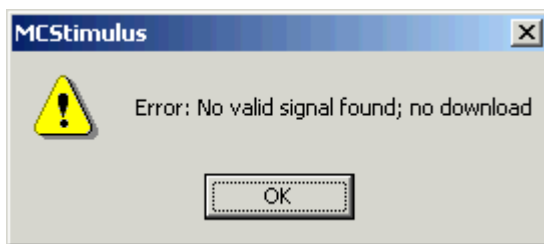

The worksheet is empty. No data is present that can be downloaded. Please create a stimulus or open a stimulus file before downloading. In **Multi-File** mode, the corresponding file will be completely ignored.

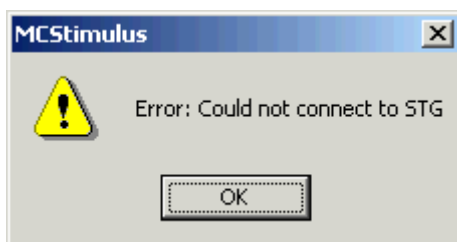

There is no stimulus generator connected to the computer or the STG may be switched off. Please check the computer connection and the status lamp of the STG.

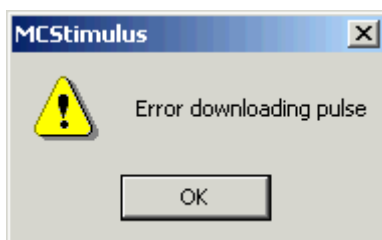

There is no valid connection to an STG. Download of data is not possible. Please check the computer connection and the status lamp of the STG.



The last voltage / current values of the named channels are not zero. The current / voltage levels are set to **zero** after the last value. The last used values of these channels are **kept** until the STG is stopped.

## ASCII Import

These error messages relate to a wrong file format. Please see chapter "Supported File Format" for more information.

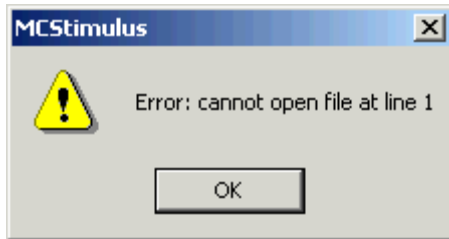

The named line contains an unexpected character.



The channel number specification has to precede the data. The channel number either lacks or the specified number does not exist, for example number 13.

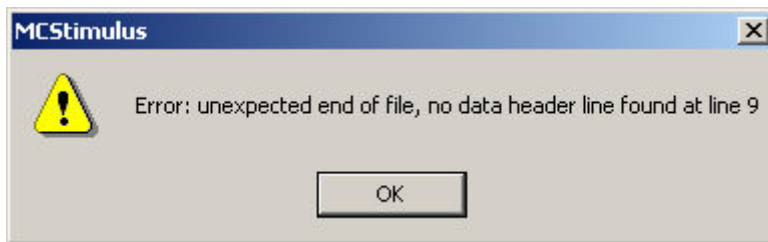

Each data column must have a header (*value*, *time*, or *repeat*).

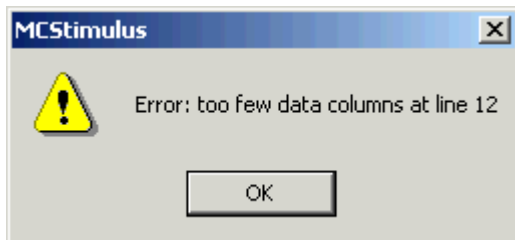

The number of data columns has to be consistent for all lines in a given ASCII file (for example, *value*, *time*, *value*, *time*). This error message indicates that there is a current/voltage value or a time point missing in line 12.

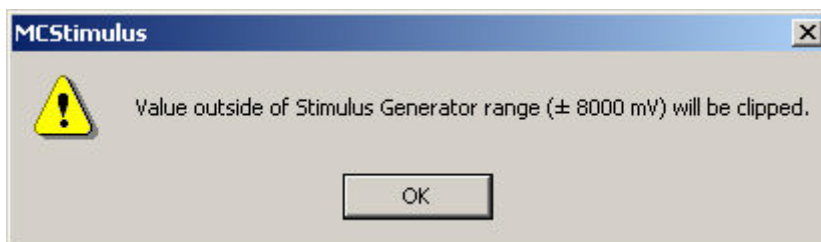

The ASCII file contains current/voltage values outside the STG's range. For example, if the STG's output range is +8000 mV, all values above +8000 mV are set to +8000 mV.

## 12.4 Signal terminated when using Trigger In

If you use the **Trigger In** to start the STG and the stimulation protocol is terminated right after start, check the Trigger Settings. If the **Use Trigger as Gate** function is selected, a protocol will only be active as long as the Trigger is HIGH. If the **Single Trigger** function is selected, the STG is armed and waits for an external trigger to execute the stimulus protocol one time only. Switch to **Stop, Restart** or **Ignore**.

## 12.5 Strong Peak Artifacts

Strong discharges or other artefacts of the output voltage or current.

*Possible causes:*

One or both current outputs are open, that is, nothing is connected to them. The stimulus generator tries to hold a stable current against the indefinite resistance of the open current output. Therefore, the stimulus generator will increase the output voltage on the open current outputs to its maximum, which will result in a heavy load on the power supply. This situation may cause the power supply to become unstable, which may lead to artifacts on all channels.

**In current mode: Connect** the **unused current** output to ground (GND). Please see also the recommended setups in the chapter "Current Mode".

## 12.6 Output Signal does not Match Programmed Signal

The amplitude or the duration of the output pulses differs from the programmed signal.

*Possible causes:*

The stimulus protocol works near the resolution limits of the STG, that is, the pulses are very short or the amplitudes very low (**smaller than 50 mV or 10  $\mu$ A**).

- Check the output signals with an oscilloscope and modify the pulse protocol so that the amplitude and timing of the pulses will match your requirements.

You operate the STG in **current mode**, and the **electrode resistance** of the **stimulating electrodes** is **too high**. According to Ohm's law, the electrode resistance directly affects the kinetics of the current output. The rise time increases with an increasing electrode resistance. If the electrode resistance is too high for the compliance voltage, the output signal will be clipped.

- Try to stimulate in **voltage mode**.
- Try to use stimulating electrodes with a **lower impedance**.
- Check the output signals with an oscilloscope and modify the pulse protocol so that the amplitude and timing of the pulses will match your requirements.

## 12.7 Internal Calibration Signals

The STG emits sometimes autonomous high frequency signals.

Cause:

During the first ten minutes after starting the STG, the device emits every minute high frequency signals (small bursts) for internal offset calibration of the current outputs in a range of +/- 10 mV. After warming up the STG, the calibration signals later will be delivered half-hourly.

The calibration is interrupted during stimulation.

High sensitive measuring equipments will monitor these calibration signals. Biological signals are usually slower than the high frequency bursts and will not interfere with the calibration signals.

When monitoring the experimental signals with MC\_Rack software, you do not see the calibration signals, because MC\_Rack automatically applies a 3 kHz low pass filter during data acquisition, and a 10 kHz low pass filter during filter activities.

When using MC\_Stimulus II Version 3.3 and higher it is possible to avoid the internal offset calibration. Enable the command "Disable Autocalibration" in main menu "STG" and download the command to the STG.

## 13 Appendix

### 13.1 Technical Specifications STG 4002

Operating temperature	10 °C to 50 °C
Storage temperature	0 °C to 70 °C
Dimensions (W x D x H)	235 x 170 x 60 mm
Weight	1.2 kg
Fuse	internal, 3.15 A slow
Supply voltage (external power supply)	100 - 240 VAC @ 47 to 63 Hz
Number of analog output channels	2
Output voltage	-8 V to +8V @ max. $\pm$ 20 mA
Output voltage resolution	1 mV
Rise time (10-90 %) voltage	1.7 $\mu$ s @ $\Delta U = 8$ V
Time lag between Sync Out and voltage output	15 ( $\pm$ 2) $\mu$ s @ amplitude > 200 mV
Output current	Standard : -1.6 mA to +1.6 mA @ max.120 V compliance voltage (between +I and -I) Or : -16 mA to +16 mA @ max.120 V compliance voltage (between +I and -I) Or : -160 $\mu$ A to +160 $\mu$ A @ max.120 V compliance voltage (between +I and -I)
Output current resolution	Standard : 200 nA Or : 2000 nA Or : 20 nA
Output current slope	600 $\mu$ A/ $\mu$ s @ $R_L = 10$ k $\Omega$
Rise time (10-90 %) current, 0-100 $\mu$ A	1.4 $\mu$ s @ $R_L = 10$ k $\Omega$
Time lag between Sync Out and current output, 0 - 100 $\mu$ A	15 ( $\pm$ 2) $\mu$ s @ $R_L = 10$ k $\Omega$ if continuous mode is enabled 50 ( $\pm$ 2) $\mu$ s @ $R_L = 10$ k $\Omega$ if continuous mode is disabled
Resolution	14 bit
Time resolution	20 $\mu$ s
Output signals	Freely programmable (rectangular, ramp, sinusoidal)
Maximum frequency (rectangular waveform)	25 kHz
Memory capacity for stored waveforms	64 MB



<b>Timing on external trigger</b>	
Minimum time length of trigger input (TTL)	40 $\mu$ s
Time lag between trigger input and Sync Out	70 ( $\pm$ 10) $\mu$ s
Maximum trigger input frequency	10 kHz
<b>Interface and connectors</b>	
Connectors for stimulation channels	2 mm banana plugs
Sync Out for synchronization with following devices	2 digital channels via coax cable
Trigger In for synchronization with preceding devices	2 digital channels via coax cable
Interface (connection to computer)	USB 2.0 High Speed
Download rate	max. 480 Mb per second
<b>Software</b>	
MC_Stimulus II	Version 3.4.4 and higher
Operating system	Microsoft Windows <sup>®</sup> 10, 8 and 7 (32 or 64 Bit), English and German versions supported
Data import / export	ASCII file format

Note: Other configurations of output currents are available on request. Please contact MCS.

## 13.2 Contact Information

### **Local retailer**

Please see the list of official MCS distributors on the MCS web site.

### **Mailing list**

If you have subscribed to the newsletter, you will be automatically informed about new software releases, upcoming events, and other news on the product line. You can subscribe to the list on the contact form of the MCS web site.

[www.multichannelsystems.com](http://www.multichannelsystems.com)

## 14 Index

<b>A</b>	
About dialog	51
Adjusting	
Stimulus Intensity Level	31
Amplifier	
blanking	55
connecting	68, 72
Amplitude	
adjusting stimulus intensity level	31
effects on rise time	76
of sine wave	16
Analog	
current output	72
input	7
voltage output	68
Arrange Icons	51
ASCII	
Import without Header	34
importing ASCII files	33
supported file format	34
Assign	
channels to Auto Sync	29
files to trigger	62
trigger inputs to multiple files	62
trigger to channels	58
trigger to Sync Outs	58
Auto Download	
stimulus intensity level	31
Autocalibration	9
disable	9
Autocreating	
stimuli	21
Autofill	21
Autorepeat	
pulses or complete pulse protocols	18
<b>B</b>	
Back panel	7
Batch	
menu	51
mode	64
Batch Mode	64
Biphasic pulse	16, 90
Blanking	
amplifier	55
autocreating blanking pulses	29
signal	55
BNC	
connection to oscilloscope	75
connectors	7
<b>C</b>	
Cables	
shielding	68, 72
twisted pair	68
Capacitive	
behavior of electrodes	90
Cascade	51
Change All	
stimulus intensity level	31
Change Time Unit	21
Channels	
connecting	7
displaying	43
downloading	47
editing	15
Clear	
file assignment in Multi File mode	62
Compiler warnings	54
Connecting	
the STG to an amplifier	7
the STG to an oscilloscope	75
Contact	
information	98
Continuous	
stimulation	18
Copy	
row	52
shortcut key	53
Count	21
Creating	
Autosync pulses	29
Stimuli	15
Current	
capacitive behavior of electrodes	90
electrode impedance	76
maximum output current	72, 97
measuring output with an	
oscilloscope	75
oscilloscope	72
output mode	15, 67, 72
resolution	16
Cursor	44
Cut	
rows	52
shortcut key	53
<b>D</b>	
Data	
ASCII file format	34
download	47
save	53
Digital	
blanking signal	55
input	7, 56
output	7, 55
port	7

Display	
Auto Sync output .....	29
scrolling.....	44
selecting channels .....	43
settings.....	43
zooming.....	44
Downloading	
batch mode.....	64
shortcut key.....	53
stimulus files.....	47
Driver	
installation.....	8
Duration	
pulse .....	16
<b>E</b>	
Edit	
Auto Sync Settings .....	29
menu.....	51
Multi File mode .....	62
Trigger Settings .....	58
Electrode	
capacitive behavior .....	90
End	
point of ramp .....	16
run .....	9
Error Messages	92
<b>F</b>	
Faraday cage	
connecting .....	68, 72
File	
Batch mode.....	64
importing ASCII files .....	33
menu.....	51
Multi File mode .....	62
new.....	52
open.....	52
save.....	52
Format	
ASCII file.....	34
time axis.....	43
<b>G</b>	
GND outputs	
about .....	67
connecting .....	68, 72
Ground	
connecting .....	68, 72
input .....	7
outputs.....	67
Group	
Group Repeat.....	18
Group/Ungroup.....	18
<b>H</b>	
Header	
of ASCII file.....	34
Help	
menu.....	51
<b>I</b>	
I outputs	
about.....	67, 72
measuring with an oscilloscope.....	75
Icons	
arrange.....	51
Ignore	
files on trigger .....	62
trigger events if channels still active ....	58
Importing	
ASCII files.....	33
supported ASCII file format.....	34
Incrementing	
values in a column .....	21
Independent Channel Download	47
Input	
analog .....	7
MC_Card .....	7
MEA1060 .....	7
trigger (Multi File mode) .....	62
trigger settings.....	58
TTL.....	56
Installing	
Software.....	8
STG driver.....	8
Inverting	
pulses .....	21
selection .....	21
<b>K</b>	
Keep Zero	21
<b>L</b>	
Length	
of pulse .....	16
Load resistance	
effects on rise time .....	76
Loading	
ASCII files.....	33
files in Batch mode .....	64
<b>M</b>	
MC_Card	
connecting.....	7
MEA1060	
connecting.....	7
Measure tool	44
Message boxes	
warning messages .....	54

Monophasic pulse	90
Multi-File mode	62
Multiple STGs	
controlling	9
Operating	12
<b>N</b>	
New File	52
<b>O</b>	
Open	
ASCII files	33
file	52
files in Multi File mode	62
shortcut key	53
stimulus files	53
Oscilloscope	
comparing STG current signals	84
measuring current signals	72
measuring STG output with an	
oscilloscope	75
measuring STG signals	68
Output	
analog output signals	67
autocreating Sync Out pulses	29
doubling amplitude	68
measuring with an oscilloscope	75
mode	15
signal inversion	68, 72
Sync Out settings	58
<b>P</b>	
Panel	
rear panel	7
Paste	
rows	52
shortcut key	53
Period	
of sine wave	16
Port	
digital	7
serial	7
USB	7
Post Time	29
Pre Time	29
Print	
preview	53
printing worksheet	53
setup	53
shortcut key	53
Pulse	
Autocreating Sync Out pulses	29
duration	16
length	16
types	16

<b>R</b>	
Ramp	
pulse type	16
Rear panel	7
Rectangular	
pulse type	16
Repeating	
a group of rows	18
continuously	18
on a trigger	18
pulses	18
rows	18
Requirements	
system	8
Reset	
display	44
STG	51
Reset All	
stimulus intensity level	31
Resolution	
current	16
time	16
voltage	16
Restart	
channels on a trigger	58
files on trigger	62
Rise Time	76
Rising edge	
of TTL signal	56
time offset (Auto Sync)	29
Row Repeat	18
Run	
STG	9
<b>S</b>	
Save	
file	52
shortcut key	53
stimulus files	53
trigger settings	58
Scrolling	44
Select Device	9
change	9
multiple	9
Serial port	7
Settings	
Auto Sync	29
menu	51
Multi File mode	62
Sync Out	58
trigger	58
shielding	
cables	68, 72

Shifting values.....	21	triggering sweeps .....	56
Show		Switch	
Auto Sync output .....	29	circuit diagram.....	56
measure tool .....	44	Sync Out	
Signal		autocreating Sync Out pulses.....	29
blanking .....	55	connectors.....	7
current mode .....	72	digital TTL outputs.....	55
measuring output signals with an		settings.....	58
oscilloscope .....	75	System requirements	8
menu.....	51	<b>T</b>	
Sync Out.....	55	Tile	51
voltage mode .....	68	Time	
Sine wave		axis format.....	43
pulse type.....	16	change time units .....	21
Single Trigger	58	resolution .....	16
Size to fit	44	rise time.....	76
Software		time offset for Auto Sync.....	29
installation.....	8	Timing	
requirements .....	8	blanking of amplifier.....	55
Start		rise time.....	76
channels on trigger.....	58	Toolbar	
files on trigger.....	62	position .....	51
shortcut key.....	53	Trigger	
STG .....	9	blanking signal.....	55
Starting		connectors.....	7
point of ramp .....	16	continuous mode.....	18, 58
STG		files.....	62
connecting .....	7	gate.....	18, 58
installing.....	8	gating trigger.....	18, 58
menu.....	51	input.....	56
starting.....	9, 56	LED Start/Stop Button .....	9
Stimuli		manual .....	9
creating.....	15	output .....	55
Stimulus Files		repeating pulses.....	18
ASCII Import without Header .....	34	separate.....	9
downloading .....	47	settings.....	58
triggering multiple files.....	62	single trigger.....	58
Stimulus Intensity Level		STG .....	9, 56
Adjusting.....	31	triggering multiple files on different	
Stop		triggers (Multi File mode).....	62
Batch menu.....	64	triggering multiple files on same	
channels on a trigger.....	58	trigger (Batch mode).....	64
files on trigger .....	62	Troubleshooting	91
shortcut key.....	53	TTL	
STG .....	52	autocreating Sync Out pulses.....	29
stopping STG.....	9	blanking signal.....	55
Support	91	digital output.....	55
Sweep		Sync Out settings.....	58
LED Start/Stop buttons .....	9	trigger settings.....	58
starting STG on trigger .....	9	triggering.....	56
status lamp.....	56	triggering in Multi File mode.....	62
sweep count.....	58	twisted pair cables	68
triggering .....	58	<b>U</b>	
		U outputs	

<i>about</i> .....	67, 68
<i>measuring with an oscilloscope</i> .....	75
<i>oscilloscope</i> .....	68
<i>voltage mode</i> .....	68
<i>Undo</i>	
<i>shortcut key</i> .....	53
<i>Update</i>	
<i>software</i> .....	8
<i>USB connector</i>	7
<i>USB-MEA32-STIM4-System</i>	12
<i>Select Stimulation Channels</i> .....	12
<b>V</b>	
<i>View</i>	
<i>menu</i> .....	51
<i>Voltage</i>	
<i>maximum output</i> .....	68, 97
<i>measuring output with an</i>	
<i>oscilloscope</i> .....	75
<i>output mode</i> .....	15, 67, 68
<i>resolution</i> .....	16
<b>W</b>	
<i>Warning messages</i>	
<i>disabling</i> .....	47
<i>Window</i>	
<i>menu</i> .....	51
<i>WYSIWYG window</i> .....	43, 44
<b>Z</b>	
<i>Zooming</i>	44